



英威腾|产品说明书|

储能逆变器

XD3~6KTL



深圳市英威腾光伏科技有限公司
INVT Solar Technology (Shenzhen) Co., Ltd

目 录

第 1 章 简介	1
第 2 章 安全注意事项	2
2.1 安全标识	2
2.2 使用注意事项	2
第 3 章 产品介绍	4
3.1 适用人员	4
3.2 产品概述	4
3.3 安全说明	5
3.4 基础系统示意图	6
3.5 产品特点	6
第 4 章 安装	8
4.1 拆包装确认	8
4.2 安装前准备	9
4.2.1 安装工具	9
4.2.2 安装环境	10
4.3 空间要求	10
4.4 安装挂板尺寸	12
4.5 机器尺寸和重量	12
4.6 墙面安装	13
4.7 安装逆变器	13
第 5 章 电气连接	15
5.1 电气连接总览	15
5.2 PV 接线	17
5.3 AC 接线	17
5.4 BAT 接线	18
5.5 通讯接线	19
5.5.1 锂电池连接	19
5.5.2 铅酸电池温度传感器连接	19
5.6 CT 连接	20
5.7 电表连接	21
5.8 地线连接	22
5.9 并机接线	23
第 6 章 设备试运行	24

6.1 设备运行	24
6.2 设备关闭	24
第 7 章 参数设置	25
7.1 菜单信息	25
7.1.1 光伏输入信息	26
7.1.2 并网输出信息	26
7.1.3 电池信息	26
7.1.4 离网输出信息	27
7.1.5 基本信息	27
7.1.6 电能信息	27
7.1.7 故障信息	28
7.1.8 设置信息	28
7.2 设置信息页面	29
7.2.1 日期和时间设置	30
7.2.2 通讯地址设置	32
7.2.3 语言设置	33
7.2.4 电表设置	34
7.2.5 电池参数设置	35
7.2.6 国家安规设置	39
7.2.7 离网设置	40
7.2.8 优先级设置	42
7.2.9 自动测试设置	47
7.2.10 恢复出厂设置	48
7.2.11 防逆流电表设置	50
7.2.12 并网角色设置	51
第 8 章 系统调试	52
8.1 显示屏和按键	52
8.1.1 LCD 显示屏	52
8.1.2 LED 灯和屏幕按键说明	53
8.2 工作模式	54
8.2.1 正常模式	54
8.2.2 故障状态	54
8.2.3 固件升级	54
8.2.4 自检状态	55
8.2.5 待机状态	55
8.2.6 关机状态	55

8.3 通过 Solarman App 设置储能逆变器参数	55
第 9 章 系统维护	56
9.1 逆变器定期维护	56
9.2 逆变器下电	56
9.3 拆除逆变器	57
9.4 报废逆变器	57
第 10 章 故障检修	58
第 11 章 规格参数	64

第 1 章 简介

本手册主要介绍英威腾储能逆变器的产品信息及安装、操作和维护。





请在安装、使用本产品之前，认真阅读本手册，了解产品安全信息并熟悉产品的功能和特点。由于产品开发方面的变化，本手册内容可能会不定期更新，请从官网获取最新版本资料及产品更多信息。

第 2 章 安全注意事项

使用不当可能导致触电危险或灼伤。本手册包含安装和维护过程中应遵守的重要说明。使用前请仔细阅读本说明，并妥善保存以备将来参考。

2.1 安全标识

以下列出本手册中用于提示潜在安全风险和重要的安全信息的安全标识：

	警告： 警告标识表示重要的安全说明，如果使用不当，可能会导致严重的人身伤害甚至死亡。
	触电危险： 注意，触电危险标识表示重要的安全说明，如果不遵守，可能会导致触电。
	安全提示： 警告标识表示重要的安全说明，如果不遵守，可能会导致严重的人身伤害甚至死亡。
	高温危险： 警告标识表示安全说明，如果不严格遵守，可能导致灼伤。
	警告： 在断开逆变器的输入和输出进行维护时，请等待至少 5 分钟，等逆变器释放完剩余的电量。

2.2 使用注意事项

XD3-6KTL 系列储能逆变器是根据相关安全法规进行设计和测试。可以确保用户的人身安全。但是，电气设备如果操作不当，可能会造成触电或其他伤害。请按照以下要求操作该装置：

1. 所有的接线、安装、调试等工作均应由相关专业人士来完成。
2. 操作前务必阅读本手册，任何因不当操作而引起的故障或损失，本公司均不承担责任。
3. 安装和维护时必须先确保交流侧、直流侧以及电池侧的连接全部断开，然后至少等待 5 分钟再操作，以免触电。
4. 逆变器运行时，机箱温度较高，禁止触摸，避免烫伤。
5. 所有的电气安装必须符合当地的电气标准，且应在获得当地供电部门的许可后由专业人员将逆变器连接到电网。
6. 安装过程中，需使用绝缘工具，佩戴个人防护用品，确保人身安全。接触电子器件需佩戴静电手套、静电手环、防静电服等，保护逆变器不受静电损坏。

7. 请安装在儿童无法接触的地方。
8. 逆变器正常运行时，请勿插入或拆除交流和直流端子。
9. 逆变器的直流输入电压不得超过逆变器允许的最大直流输入电压。
10. 合理选择系统匹配电池并正确设置电池类型，如电池与储能机匹配错误，将导致系统无法运行。
11. 若电池已完全放电，请严格按照对应电池用户手册对电池进行充电维护。
12. 如系统需要维护，请联系我们在当地的授权运维服务人员或本公司专业售后人员。
13. 应在取得许可的条件下再并网使用混合储能系统。
14. 如在光照很好的白天安装太阳能光伏电池板，请确保关掉 PV 开关后再操作。否则会有严重的触电危险。
15. 请勿将同一路 PV 组串连接至多台逆变器，否则可能导致逆变器损坏。
16. 应急负载口不适合连接需依靠持续稳定供电的设备，如维持生命的医疗设备等。

第 3 章 产品介绍

3.1 适用人员

XD 系列混合储能逆变器，仅适用于熟悉当地法规标准和电气系统、经过专业培训、熟知本产品相关知识的专业人员进行安装。

强烈建议安装人员能仔细阅读本手册。通过阅读本手册，您可以获得产品安装、故障排除、通信组网等各个方面的指引。

3.2 产品概述

XD 系列机型用于将光伏系统中产生的能量或公共电网的能量存储于电池中，亦可输出至电网；在电网断电的情况下，储能逆变器可作为后备电源为负载提供能量。

本文档适用于以下混合储能逆变器机型：

XD3KTL\XD3K6TL\XD4KTL\XD4K6TL\XD5KTL\XD6KTL

Overview:

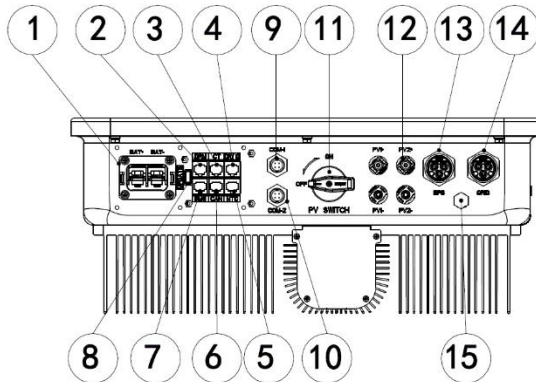

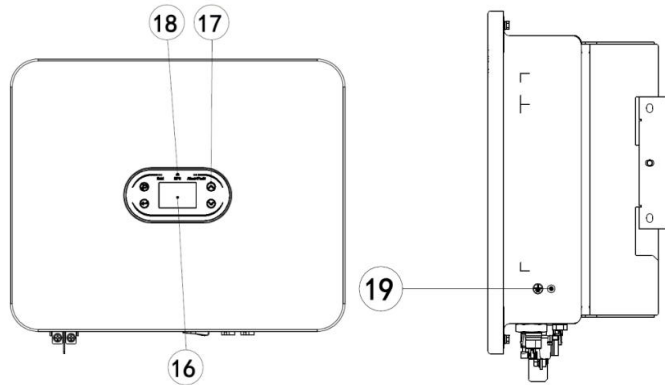

序号	释义	序号	释义
1	电池接线端子	2	DRMs 的 RJ45 接口（澳大利亚）
3	CT 的 RJ45 接口	4	干接点&NTC
5	CAN2(并机通讯)	6	CAN1(并机通讯)
7	BMS 锂电池通讯	8	USB 接口(软件升级)
9	COM-1(RS485/WiFi/GPRS 通讯)	10	COM-2(电表 RS485 通讯)
11	PV 输入直流开关	12	PV 输入端子
13	EPS 输出端子	14	电网接线端子
15	透气阀	16	LCD 显示屏
17	功能按键	18	LED 指示灯
19	GND 接地点		

3.3 安全说明

1. 操作前务必阅读本手册，任何因不当操作而引起的故障或损失，本公司均不承担责任。
2. 合理选择系统匹配电池并正确设置电池类型，如电池与储能机匹配错误，将导致系统无法运行。
3. 若电池已完全放电，请严格按照对应电池用户手册对电池进行充电维护。
4. 所有的接线、安装、调试等工作均应由相关专业人士来完成。
5. 安装过程中，需使用绝缘工具，佩戴个人防护用品，确保人身安全。接触电子器件需佩戴静电手套、静电手环、防静电服等，保护逆变器不受静电损坏。
6. 所有电气连接均需遵守当地电网公司的安全法规。
7. 如系统需要维护，请联系我们在当地的授权运维服务人员或本公司专业售后人员。
8. 应在取得许可的条件下再并网使用混合储能系统。

9. 如在光照很好的白天安装太阳能光伏电池板，请确保关掉 PV 开关后再操作。否则会有严重的触电危险。

10. 请勿将同一路 PV 组串连接至多台逆变器，否则可能导致逆变器损坏。

3.4 基础系统示意图

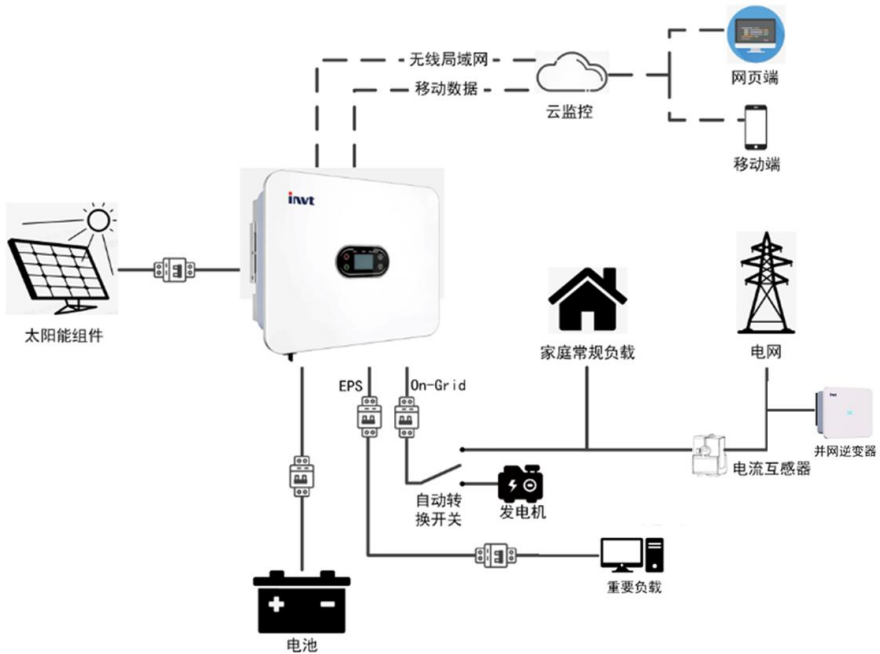

如上图所示，一个完整的 XD 系列混合储能系统须由太阳能光伏电池板、储能机、电池、电网等组成。

注意：储能系统中，电池是必要的设备之一，因此，必须保持安装环境通风良好，同时采取必要措施控制环境温度以防电池温度过高导致爆炸危险。

电池特征：

防护等级：≥IP65 污染等级：PD2 室内温度：0-40℃ 湿度：5%-85%

3.5 产品特点

1. 智能管理系统，多种工作模式，满足客户需求。
2. 通过 LCD 屏可设置并网工作优先级，电池类型等逆变器信息。
3. 双路 MPPT，大电流输入，兼容 500W+组件，灵活配置。
4. 一体化设计，具备备用电源和削峰填谷功能。
5. 具备电池安全管理系统，可对电池 BMS 进行远程升级。
6. 支持防逆流功能。

7. 具备过温/过流/短路保护等功能，保证系统安全、稳定、可靠运行。
8. 提供多样人性化的通讯模块选择，如 RS485、GPRS、WiFi 等选择，适用电脑、手机或互联监控及远程操作。
9. 支持并机系统功能，最大并机数量可达 6 台。
10. 最高转换效率高达 97.5%。
11. IP66 防护等级，重量轻，尺寸小，安装方便。

第 4 章 安装

4.1 拆包装确认

逆变器出厂前已进行完整测试和严格检查，但运输过程中仍可能出现损坏情况。开箱前仔细检查核对订单与包装箱铭牌上的产品信息是否一致，产品包装是否完好。若检查到任何损坏情况，请与运输公司或者直接与供货商联系，并提供损坏处的照片，便于提供最快最好的服务。

逆变器闲置存放时，请将其置于原包装箱内，并做好防潮防尘处理。

开箱后取出逆变器，请检查以下几项：

- (1) 确认逆变器主机完整，无损坏；
- (2) 确认包装箱中有说明书、接口配件及安装配件；
- (3) 确认包装箱中的交付内容无任何破损或者短缺；
- (4) 核对订单与逆变器主机铭牌上的产品信息是否一致；
- (5) 标准交付清单如下。

储能逆变器标准交付件：



图 4.1 储能逆变器 XD3-6KTL 交付内容

表 4-1 储能逆变器交付清单

序号	名称	数量
1	逆变器	1
2	安装支架	1
3	AC 侧快接端子和内六角螺丝刀	2
4	接线端子	1
5	直流连接器 (对)	2
6	文档 (套)	1
7	不锈钢膨胀螺栓 M6*50	6
8	M6 组合螺栓	9
9	M4 组合螺钉	6
10	M6 螺母	6
11	M6 平垫	6
12	CT	1

以上所述请仔细核对，若有任何疑问，请及时联系供货商。

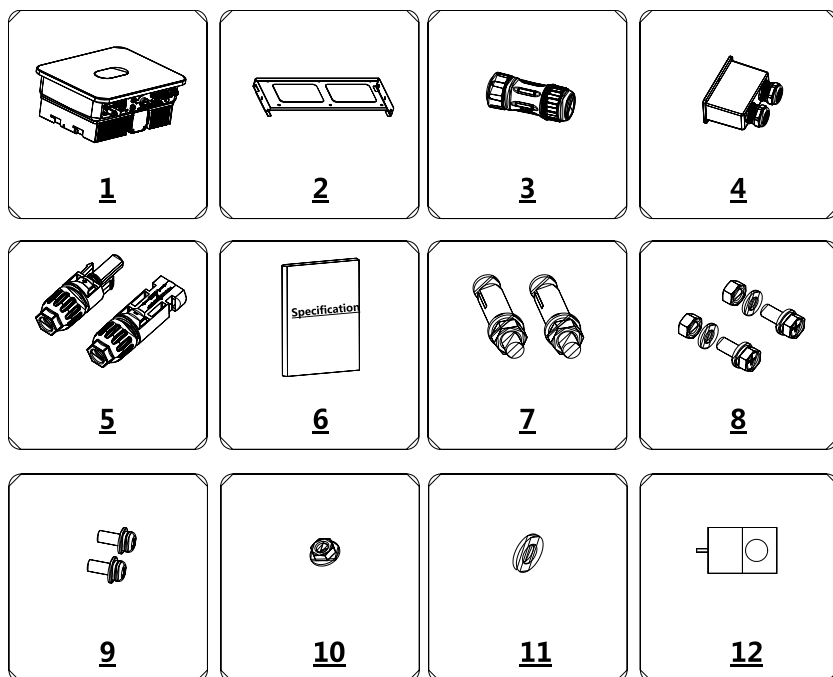
4.2 安装前准备

4.2.1 安装工具

表 4-2 安装工具列表

序号	安装工具	说明
1	记号笔	标记安装孔位
2	电钻	在支架或者墙面上钻孔
3	手锤	敲击膨胀螺栓
4	活动扳手	固定安装支架用
5	螺丝刀	固定逆变器和锁紧接线盒用
6	“—” 或 “十字” 字螺丝刀	AC 接线用
7	兆欧表	测量绝缘性能及对地阻抗
8	万用表	检测线路及测量交直流电压
9	电烙铁	焊接通讯电缆
10	压线钳	压接直流端子
11	液压钳	压接交流接线端圆环端子

4.2.2 安装环境

- (1) 逆变器室内、室外环境均可安装。
- (2) 逆变器在运行过程中，机箱和散热片温度会比较高，请勿将逆变器安装在易触碰的位置。
- (3) 请勿在存放易燃、易爆材料的区域中安装逆变器。
- (4) 逆变器应安装在通风良好的环境下，以保证良好的散热。
- (5) 建议选择带遮挡的安装地点，或者搭建遮阳棚。



图 4.2 遮阳棚

- (6) 安装环境温度为 $-30^{\circ}\text{C}\sim 60^{\circ}\text{C}$;
- (7) 安装地点应远离有强电磁干扰的电子设备;
- (8) 安装地点应为固定且坚固的物体表面，如墙面、金属支架等;
- (9) 安装位置需要保证逆变器可靠接地，且接地金属导体材料与逆变器预留接地处金属材料保持一致。

4.3 空间要求

- (1) 安装位置高度应保证视线与 LCD 显示屏在同一水平面上，以方便查看逆变器状态;

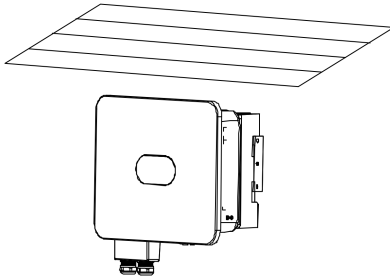

图 4.3 最佳安装高度区域

(2) 安装地点周围有足够的预留空间，便于逆变器拆装与空气对流。如图 4.4 所示；

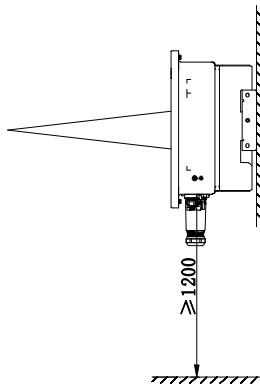

图 4.4 逆变器安装间距

(3) 安装多台逆变器时，需要在逆变器之间预留一定的间距，左右间距如图 4.5 所示，同时逆变器上下部分均需留出足够的距离，以便确保其散热良好。

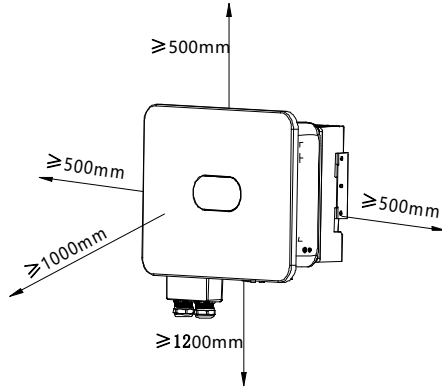

图 4.5 并排安装尺寸要求

(4) 安装表面应垂直于水平线，如图 4.6 所示。请将逆变器竖直或后仰 $\leq 15^\circ$ 安装，以利于机器散热。不可将逆变器前倾、水平、倒置、后仰过大以及侧倾安装。

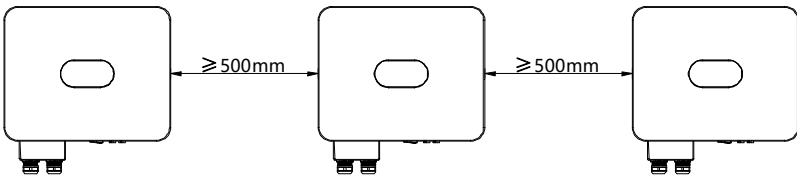

图 4.6 逆变器安装位置

4.4 安装挂板尺寸

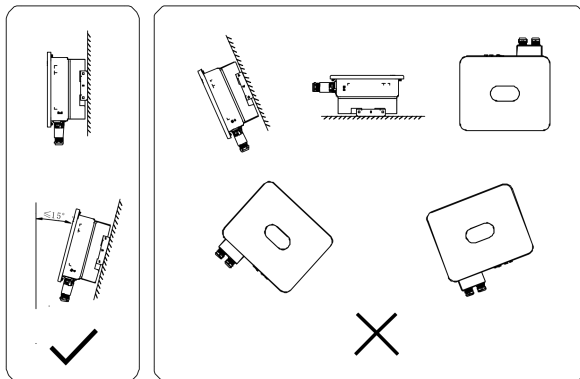

图 4.7 安装挂板尺寸图

4.5 机器尺寸和重量

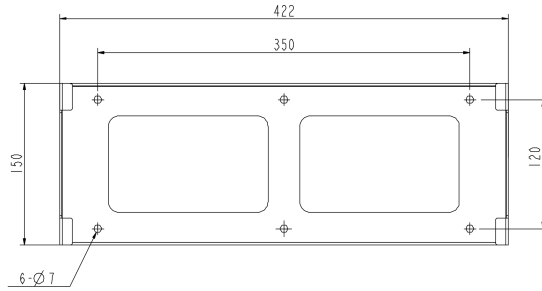

图 4.8 逆变器外形尺寸

储能逆变器尺寸及净重

型号	高度 H (mm)	宽度 W (mm)	深度 D (mm)	净重 (kg)
XD3-6KTL	390	481	200	22

包装尺寸及毛重

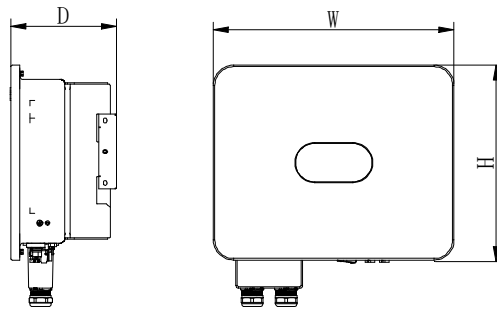
型号	高度 H (mm)	宽度 W (mm)	深度 D (mm)	重量 (kg)	包装 材质
XD3-6KTL	485	575	320	26	瓦楞纸箱

4.6 墙面安装

步骤 1: 挂墙安装，墙体厚度应大于等于 60mm，将挂板置于墙面安装点，使用水平尺调整角度，并用记号笔标记。

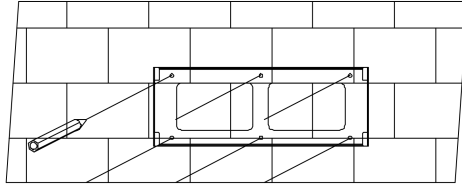

步骤 2: 使用冲击钻打孔并安装膨胀螺栓。打孔孔径为 $\phi 8$ ；孔深不小于 55mm，膨胀螺栓使用 M6 \times 50 不锈钢压爆膨胀螺栓。

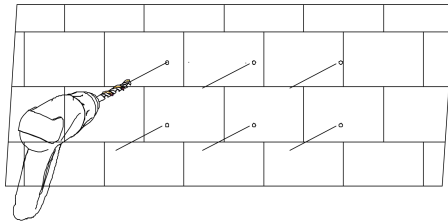

步骤 3: 固定挂板。清理孔位，将膨胀螺栓用橡胶锤打入孔中，使用扳手拧紧螺母固定螺栓尾部后，再取下螺母、弹垫和平垫，然后将壁挂板固定与墙面上锁紧，紧固力矩 5N \cdot m。

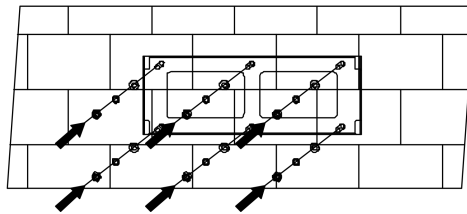

4.7 安装逆变器

步骤 1: 将逆变器由包装箱中取出。

步骤 2: 如果安装位置较高，需要将逆变器吊起至挂板上，使用起吊设备将逆变器吊离地面 100mm 后暂停，检查吊装环和绳索的紧固情况。确认连接牢固后，将逆变器起吊至目的地。

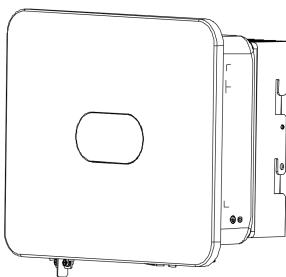

步骤 3: 将逆变器卡口对准扣入壁挂板，然后机器往下卡紧，确保机器散热器凹槽与挂板配合良好。

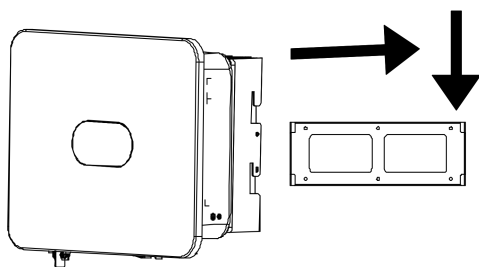

步骤 4: 散热器左右侧孔与壁挂件使用 M6×16 的螺钉固定逆变器，紧固力矩 5 N·m。

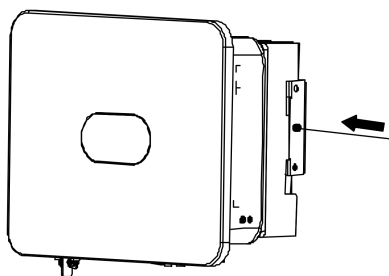

第 5 章 电气连接

5.1 电气连接总览

支持的电网形式：

注意：对于有N线的电网形式，N对地电压需小于10V。

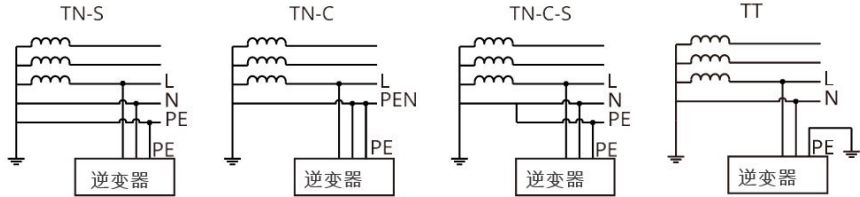

注意

- 根据不同区域的法规要求，逆变器GRID和EPS端口的N线和PE线接线方式不同，具体以当地法规要求为准。
- 逆变器GRID和EPS交流端口内置继电器。当逆变器处于离网模式时，内置GRID继电器处于断开状态；当逆变器处于并网工作模式时，内置GRID继电器处于闭合状态。
- 当逆变器上电后，EPS交流端口带电，如需对EPS负载进行维护，请将逆变器下电，否则可能导致电击。

注意

澳洲、新西兰、南非等区域适用于如下接线方式：

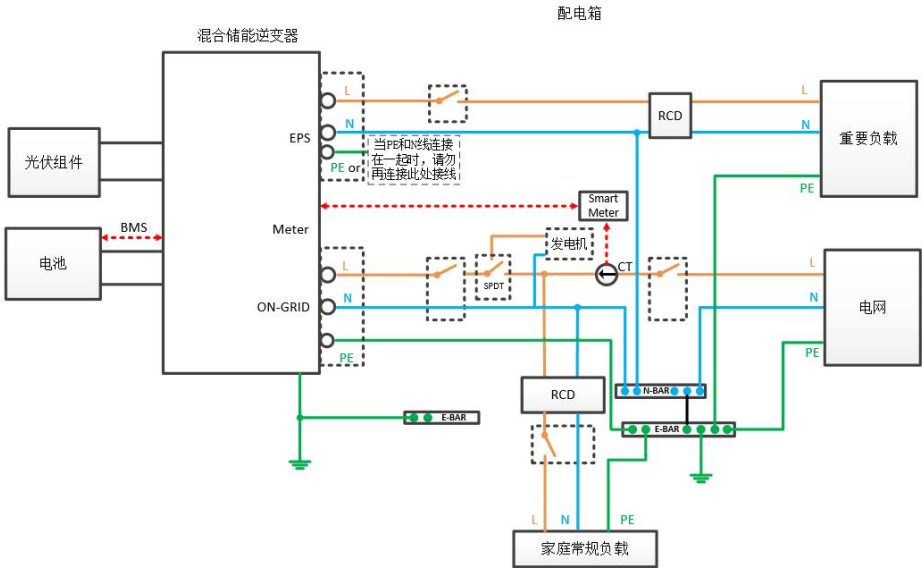

注意

- 请确保BACK-UP的保护地线连接正确且紧固，否则当发生电网故障时BACK-UP功能可能会出现异常。
- 澳洲、新西兰、南非等区域外的其他区域适用于如下接线方式：

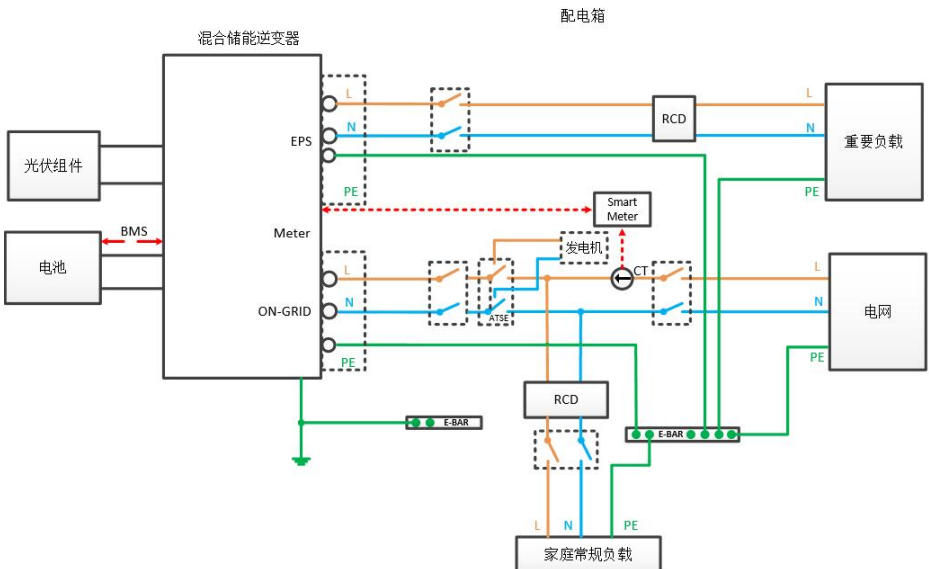

5.2 PV 接线

储能系列直流输入侧使用MC4接头。具体连接步骤如下：

1. 关断直流开关；
2. 将组件正负极分别接入到储能机上的PV+/PV-。请确保输入电压和电流在允许范围内：

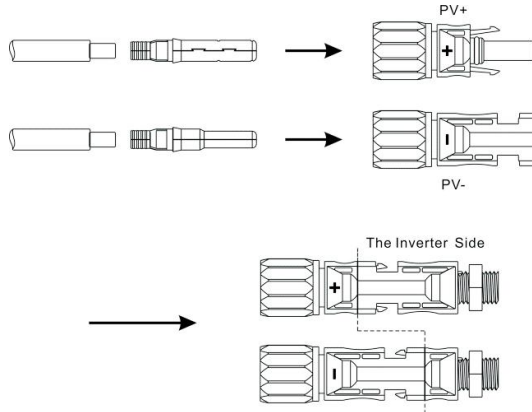

- 最大PV输入电压：600V（须考虑最低温度下电压的变化）
- 最大PV输入电流：16A

注：建议您选用光伏专用线缆，线径 $\geq 4\text{mm}^2$ (11AWG)。

5.3 AC 接线

交流输出位于储能逆变器的右下方，其左侧端子为离网接线端，右侧端子为电网接线端（产品介绍章节有详细位置说明）

步骤一：拧开交流接线端子，应用配带工具，拆下交流接线端子，如下图：

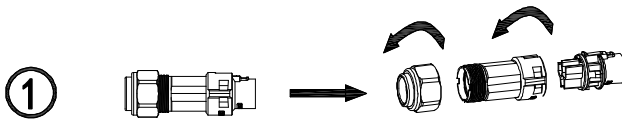

步骤二：线缆依次穿过橡胶螺母，密封圈，螺纹套；然后依据极性标示将线缆接到相应的端子上，将螺纹套用力与交流接线端子扭紧，如下图：

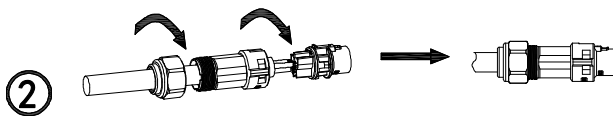

步骤三：将组装好线的交流接线端子接入到储能机上的 EPS 和 GRID 上，如下图：

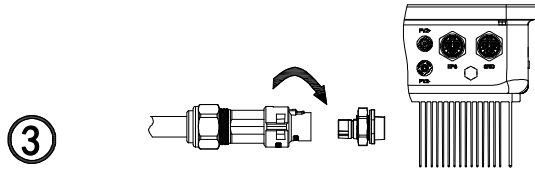

- 注：1. 如果您只使用并网功能，请将电网连接至逆变器 GRID 接口；
2. 并网端口和离网端口不可直接连接在一起，否则会导致逆变器损坏；
3. 离网端口不可连接电网，否则会导致逆变器损坏；
4. 并网和离网端口功率连接线线径 $\geq 4\text{mm}^2(11\text{AWG})$ 。

5.4 BAT 接线

安装电池功率线缆步骤如下：

1. 拧开储能机防水盖上的橡胶螺母；
2. 线缆依次穿过橡胶螺母、密封圈、螺纹套和防水盖；
3. 然后将电池线缆压接相应的O型端子（原包装中自带连接线缆）；
4. 将电池的正极连接到机器电池端子的正极，负极连接到机器电池端子的负极。

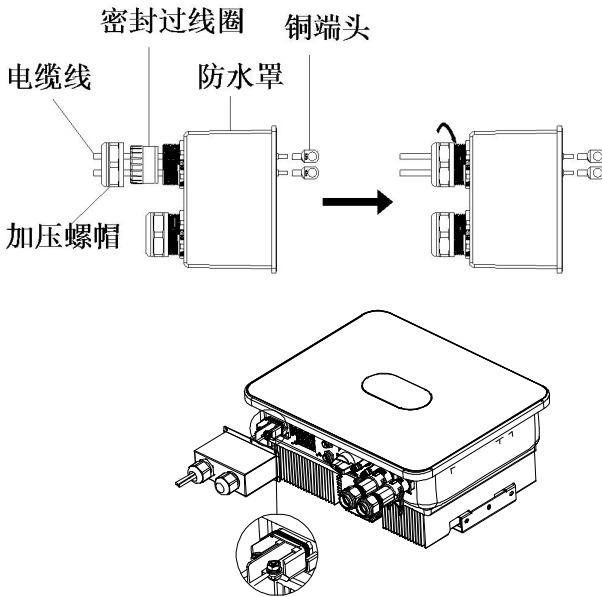

- 注：1. 电池与逆变器之间需配备一个直流开关；
2. 电池与储能机之间功率线长度 $\leq 1.5\text{m}$ ，线径 $\geq 16\text{mm}^2(5\text{AWG})$ 。

5.5 通讯接线

5.5.1 锂电池连接

当使用锂电池的时候，需要连接锂电池的BMS管理系统，连接锂电池端口的步骤如下：

1. 拧开储能机防水盖上的橡胶螺母；
2. 将LAN线依次穿过橡胶螺母、密封圈、螺纹套和防水盖；
3. 并将LAN线RJ45端子头连接至储能机上BMS端口；
4. 将防水盖用螺丝锁好；
5. 将橡胶螺母拧紧到防水盖上。

RJ45接口定义：

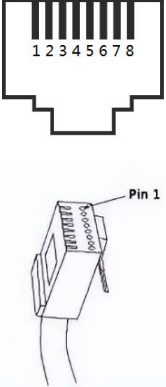
	BMS	
Pin 1		
Pin 2		
Pin 3		
Pin 4	CAN-H	
Pin 5	CAN-L	
Pin 6		
Pin 7	GND	
Pin 8	WAKE-UP	

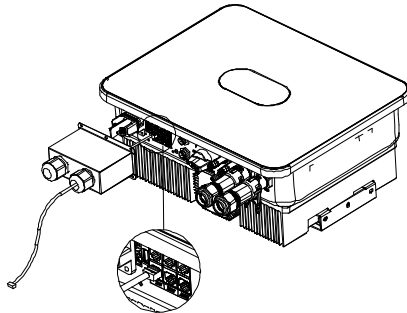

注：如果使用的是铅酸电池，则无需连接BMS通讯线，可直接跳至5.5.2。

5.5.2 铅酸电池温度传感器连接

当使用的是铅酸电池，则需要连接温度传感器来监测电池的表面温度。温度传感器连接步骤如下：

1. 拧开储能机防水盖上的橡胶螺母；
2. 将NTC线依次穿过橡胶螺母、密封圈、螺纹套和防水盖；
3. 将NTC线RJ45端子头连接至储能机上DRY IO/NTC端口；

4. 将防水盖用螺丝锁好；
5. 将橡胶螺母拧紧到防水盖上。

接口定义：

	NTC	DRY IO
Pin 1		NC OUT
Pin 2		NC OUT
Pin 3	GND	
Pin 4		COM
Pin 5		COM
Pin 6	TEMP	
Pin 7		NO OUT
Pin 8		NO OUT

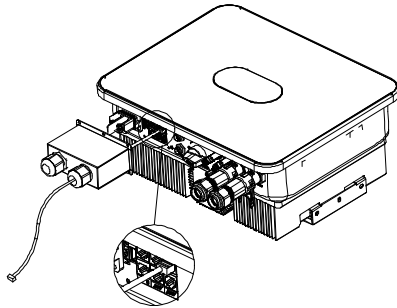

注：传感器探针用于监测铅酸电池的环温，长度应小于1.5m；如果您选择的是锂电池，则无需安装温度传感器

5.6 CT 连接

逆变器上使用的CT用于监测家庭用户的能源使用状况。CT的连接步骤如下：

1. 拧开储能机防水盖上的橡胶螺母；
2. 将CT线依次穿过橡胶螺母、密封圈、螺纹套和防水盖；
3. 并将CT线RJ45端子头连接至储能机上CT端口；
4. 将防水盖用螺丝锁好；
5. 将橡胶螺母拧紧到防水盖上。

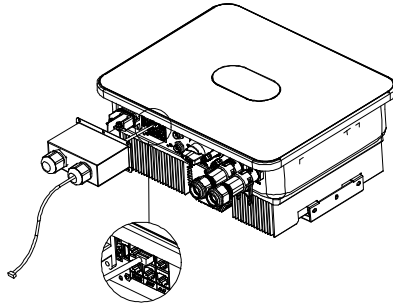

CT线（长度5m）规格：RJ45，标准LAN线（一端为8P水晶头，另一端连接电流互感器）；如果线缆长度不够，您可以增加延长线，最长可允许加至15m；请参照下图：

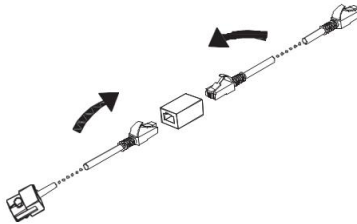

实际安装中，请注意电流互感器的安装（特别是方向），如下图：

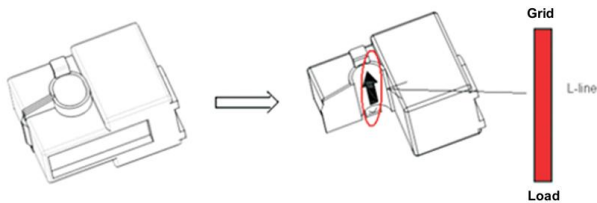

如上图，打开电流互感器，您可以看到一个箭头，指示了电流的方向。将火线从互感器的检测孔中穿过，然后锁上互感器。

注意：箭头的朝向(从K到L)对应于火线中负载到电网的方向。互感器需置于配电柜中。通讯距离应小于30m。

5.7 电表连接

用户也可以通过电表监测家庭用户的能源使用状况；电表的连通讯线连接步骤如下：

电表接于COM-2(RS485端子)，带防水功能，只需插入拧紧即可，图片如下：

注：电表和CT不能同时安装。在选择CT或电表时，请设置sensor模式，详细设置请参照第七章内容。

正泰电表接线图：

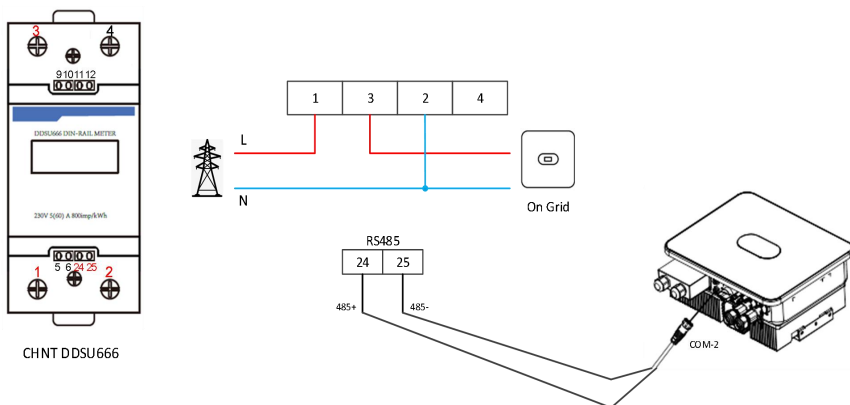

5.8 地线连接

储能机需可靠接地。建议接地线线径需大于10mm²；接地点如下图所示：

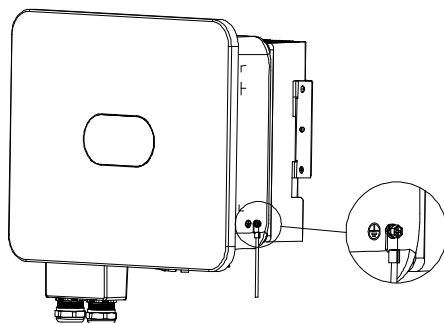

5.9 并机接线

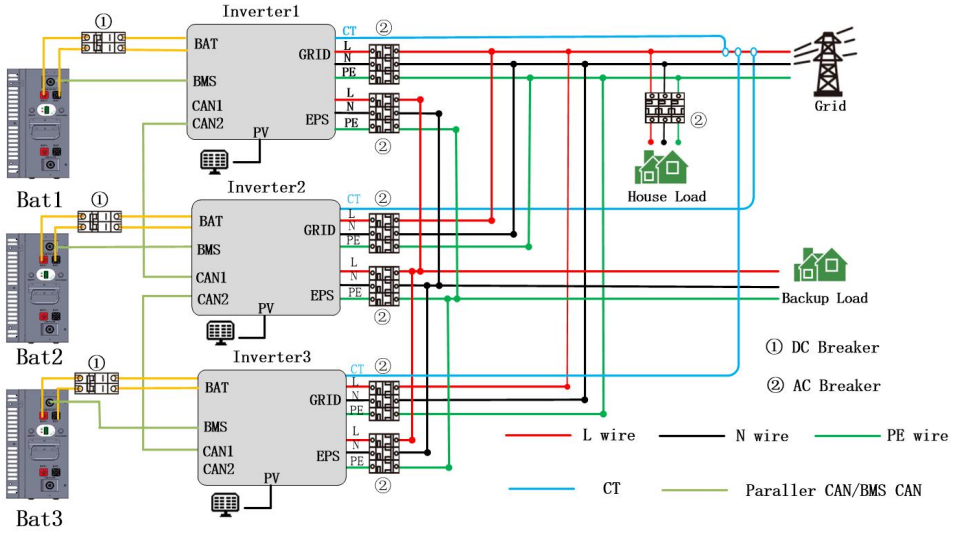

主从机设置:

<p>Setting Info</p> <p>10. Anti-Reflex Setting</p> <p>11. Set Parallel Role</p>	<p>→</p> <p>按“确认”键</p>	<p>Set Parallel Role</p> <p>Role: 1 Phase Master</p> <p>OK</p>
<p>Set Parallel Role</p> <p>Role: 1 Phase Master</p> <p>OK</p>	<p>→</p> <p>按“向上”或“向下”键可以选择主从机模式</p>	<p>Set Parallel Role</p> <p>Role: 2 Slave</p> <p>OK</p>
<p>▼ 按“确认”键</p>		<p>▼ 按“确认”键</p>

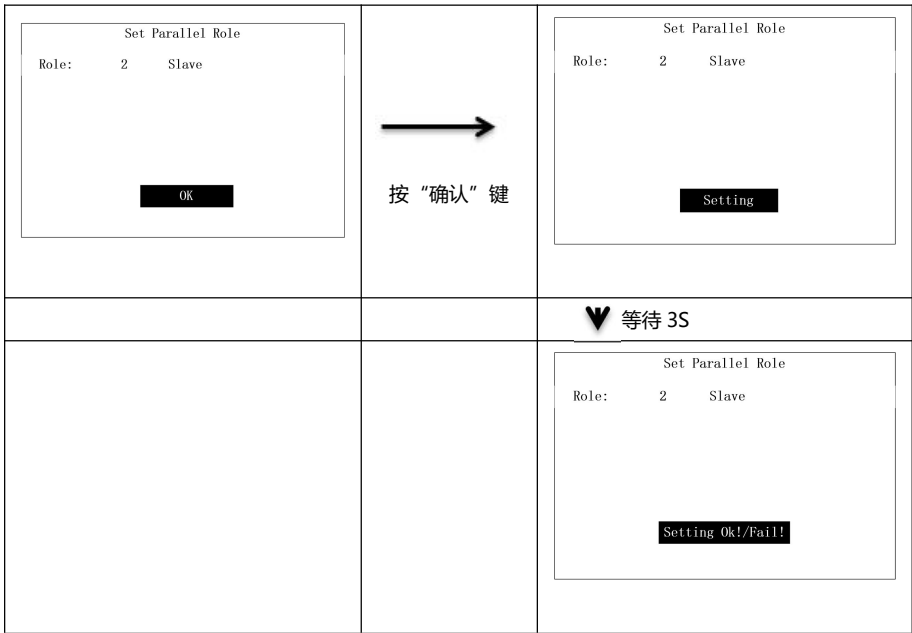

第 6 章 设备试运行

6.1 设备运行

步骤 1：闭合逆变器 GRID 侧交流断路器。

步骤 2：闭合逆变器 BAT 侧直流断路器。

步骤 3：闭合逆变器 EPS 侧交流断路器。

步骤 4：闭合逆变器 PV SWITCH。

注：PV、电网和电池均正常时，系统将工作为“并网模式”。

此时绿色 LED 灯常亮，储能机屏幕显示“State: On Grid”。

6.2 设备关闭

逆变器停止工作，必须断开所有的能量来源，然后储能机会自动进入关机模式。

步骤 1：断开 PV 侧。

步骤 2：关闭电池开关。

步骤 3：断开电网。

此时 LED 灯及 LCD 屏均熄灭。

注：当以上操作均完成后，至少需要等待 5 分钟后在再进行其他操作。

第 7 章 参数设置

LCD 显示被用来显示系统当前状态、能量流图、运行信息、故障信息，也可以设置语言，充放电优先级和系统时间。默认状态下显示主页面能量流图。

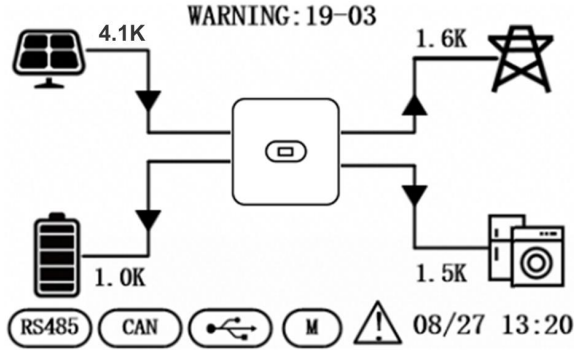

逆变器状态如下：

1. 初始化状态：在待机状态下，无故障，但由于某些原因逆变器处于等待状态；
2. 等待状态：逆变器自检，如没有故障，系统将进入待机模式或正常工作模式；
3. 并网状态：逆变器处于并网工作状态；
4. 故障状态：逆变器出现故障时将进入停机保护状态；
5. 烧录状态：逆变器正在进行程序烧录；
6. 离网状态：逆变器处于离网工作状态。

7.1 菜单信息

在主页面下，按“确认”，“退出”，“向上”，或者“向下”键都可以进入“菜单”页面。菜单页面显示如下：

Menu Info
1. PV Info
2. AC Output Info
3. BAT Info
4. EPS Output Info
5. Basic Info
6. Energy Info
7. Fault Info
8. Setting Info

在“菜单”页面下，按“向下”或者“向上”键可以选择需要查看的菜单信息。各个子菜单信息页面显示如下：

7.1.1 光伏输入信息

显示光伏输入电压，电流和功率。

<table border="1" style="width: 100%; border-collapse: collapse;"> <tr><th style="text-align: center;">Menu Info</th></tr> <tr><td>1. PV Info</td></tr> <tr><td>2. AC Output Info</td></tr> <tr><td>3. BAT Info</td></tr> <tr><td>4. EPS Output Info</td></tr> <tr><td>5. Basic Info</td></tr> <tr><td>6. Energy Info</td></tr> <tr><td>7. Fault Info</td></tr> <tr><td>8. Setting Info</td></tr> </table>	Menu Info	1. PV Info	2. AC Output Info	3. BAT Info	4. EPS Output Info	5. Basic Info	6. Energy Info	7. Fault Info	8. Setting Info	<p>————→</p> <p>按“Enter”键进入 PV 信息页面</p> <p>←————</p> <p>按“ESC”键退出 PV 信息页面</p>	<table border="1" style="width: 100%; border-collapse: collapse;"> <tr><th style="text-align: center;">PV Info</th></tr> <tr><td>PV Volt: 235.6V / 256.8V</td></tr> <tr><td>PV Curr: 13.6A / 16.8A</td></tr> <tr><td>PV Power: 3448.9W / 4314.2W</td></tr> </table>	PV Info	PV Volt: 235.6V / 256.8V	PV Curr: 13.6A / 16.8A	PV Power: 3448.9W / 4314.2W
Menu Info															
1. PV Info															
2. AC Output Info															
3. BAT Info															
4. EPS Output Info															
5. Basic Info															
6. Energy Info															
7. Fault Info															
8. Setting Info															
PV Info															
PV Volt: 235.6V / 256.8V															
PV Curr: 13.6A / 16.8A															
PV Power: 3448.9W / 4314.2W															

7.1.2 并网输出信息

显示并网电压，频率，电流，和电表功率。

<table border="1" style="width: 100%; border-collapse: collapse;"> <tr><th style="text-align: center;">Menu Info</th></tr> <tr><td>1. PV Info</td></tr> <tr><td>2. AC Output Info</td></tr> <tr><td>3. BAT Info</td></tr> <tr><td>4. EPS Output Info</td></tr> <tr><td>5. Basic Info</td></tr> <tr><td>6. Energy Info</td></tr> <tr><td>7. Fault Info</td></tr> <tr><td>8. Setting Info</td></tr> </table>	Menu Info	1. PV Info	2. AC Output Info	3. BAT Info	4. EPS Output Info	5. Basic Info	6. Energy Info	7. Fault Info	8. Setting Info	<p>————→</p> <p>按“Enter”键进入逆变输出信息页面</p> <p>←————</p> <p>按“ESC”键退出逆变输出信息页面</p>	<table border="1" style="width: 100%; border-collapse: collapse;"> <tr><th style="text-align: center;">AC Output Info</th></tr> <tr><td>AC Volt: 235.6V</td></tr> <tr><td>AC Freq: 50.1Hz</td></tr> <tr><td>AC Curr: 30.6A</td></tr> <tr><td>METER Power: -2443.3W</td></tr> </table>	AC Output Info	AC Volt: 235.6V	AC Freq: 50.1Hz	AC Curr: 30.6A	METER Power: -2443.3W
Menu Info																
1. PV Info																
2. AC Output Info																
3. BAT Info																
4. EPS Output Info																
5. Basic Info																
6. Energy Info																
7. Fault Info																
8. Setting Info																
AC Output Info																
AC Volt: 235.6V																
AC Freq: 50.1Hz																
AC Curr: 30.6A																
METER Power: -2443.3W																

7.1.3 电池信息

显示电池类型，电池电压，电池电流，电池功率和电池 SOC。

<table border="1" style="width: 100%; border-collapse: collapse;"> <tr><th style="text-align: center;">Menu Info</th></tr> <tr><td>1. PV Info</td></tr> <tr><td>2. AC Output Info</td></tr> <tr><td>3. BAT Info</td></tr> <tr><td>4. EPS Output Info</td></tr> <tr><td>5. Basic Info</td></tr> <tr><td>6. Energy Info</td></tr> <tr><td>7. Fault Info</td></tr> <tr><td>8. Setting Info</td></tr> </table>	Menu Info	1. PV Info	2. AC Output Info	3. BAT Info	4. EPS Output Info	5. Basic Info	6. Energy Info	7. Fault Info	8. Setting Info	<p>————→</p> <p>按“Enter”键进入电池信息页面</p> <p>←————</p> <p>按“ESC”键退出电池信息页面</p>	<table border="1" style="width: 100%; border-collapse: collapse;"> <tr><th style="text-align: center;">BAT Info</th></tr> <tr><td>BAT Type: lead acid</td></tr> <tr><td>BAT Volt: 47.3V</td></tr> <tr><td>BAT Curr: 97.5A</td></tr> <tr><td>BAT Power: 4526.6W</td></tr> <tr><td>BAT SOC: 87%</td></tr> </table>	BAT Info	BAT Type: lead acid	BAT Volt: 47.3V	BAT Curr: 97.5A	BAT Power: 4526.6W	BAT SOC: 87%
Menu Info																	
1. PV Info																	
2. AC Output Info																	
3. BAT Info																	
4. EPS Output Info																	
5. Basic Info																	
6. Energy Info																	
7. Fault Info																	
8. Setting Info																	
BAT Info																	
BAT Type: lead acid																	
BAT Volt: 47.3V																	
BAT Curr: 97.5A																	
BAT Power: 4526.6W																	
BAT SOC: 87%																	

7.1.4 离网输出信息

显示离网输出电压，频率，电流，以及离网输出功率和负载功率。

<table border="1" style="width: 100%; border-collapse: collapse;"> <tr><th style="text-align: center;">Menu Info</th></tr> <tr><td>1. PV Info</td></tr> <tr><td>2. AC Output Info</td></tr> <tr><td>3. BAT Info</td></tr> <tr style="background-color: black; color: white;"><td>4. EPS Output Info</td></tr> <tr><td>5. Basic Info</td></tr> <tr><td>6. Energy Info</td></tr> <tr><td>7. Fault Info</td></tr> <tr><td>8. Setting Info</td></tr> </table>	Menu Info	1. PV Info	2. AC Output Info	3. BAT Info	4. EPS Output Info	5. Basic Info	6. Energy Info	7. Fault Info	8. Setting Info	<p>→</p> <p>按“Enter”键进入离网输出信息页面</p> <p>←</p> <p>按“ESC”键退出离网输出信息页面</p>	<table border="1" style="width: 100%; border-collapse: collapse;"> <tr><th style="text-align: center;">EPS Output Info</th></tr> <tr><td>EPS Volt: 230.5V</td></tr> <tr><td>EPS Freq: 50.0Hz</td></tr> <tr><td>EPS Curr: 10.6A</td></tr> <tr><td>EPS Power: 2443.3W</td></tr> </table>	EPS Output Info	EPS Volt: 230.5V	EPS Freq: 50.0Hz	EPS Curr: 10.6A	EPS Power: 2443.3W
Menu Info																
1. PV Info																
2. AC Output Info																
3. BAT Info																
4. EPS Output Info																
5. Basic Info																
6. Energy Info																
7. Fault Info																
8. Setting Info																
EPS Output Info																
EPS Volt: 230.5V																
EPS Freq: 50.0Hz																
EPS Curr: 10.6A																
EPS Power: 2443.3W																

7.1.5 基本信息

显示日期时间，额定功率，序列号，通讯地址和软件版本号等信息。

<table border="1" style="width: 100%; border-collapse: collapse;"> <tr><th style="text-align: center;">Menu Info</th></tr> <tr><td>1. PV Info</td></tr> <tr><td>2. AC Output Info</td></tr> <tr><td>3. BAT Info</td></tr> <tr><td>4. EPS Output Info</td></tr> <tr style="background-color: black; color: white;"><td>5. Basic Info</td></tr> <tr><td>6. Energy Info</td></tr> <tr><td>7. Fault Info</td></tr> <tr><td>8. Setting Info</td></tr> </table>	Menu Info	1. PV Info	2. AC Output Info	3. BAT Info	4. EPS Output Info	5. Basic Info	6. Energy Info	7. Fault Info	8. Setting Info	<p>→</p> <p>按“Enter”键进入基本信息页面</p> <p>←</p> <p>按“ESC”键退出基本信息页面</p>	<table border="1" style="width: 100%; border-collapse: collapse;"> <tr><th style="text-align: center;">Basic Info</th></tr> <tr><td>Date & Time : 22/08/23 11:40</td></tr> <tr><td>Rate Power : 6000W</td></tr> <tr><td>Model: 00F0-0980-0030-0900</td></tr> <tr><td>SN: F00123456790</td></tr> <tr><td>COM Addr: 1</td></tr> <tr><td>FW: 510-012-109-1102</td></tr> </table>	Basic Info	Date & Time : 22/08/23 11:40	Rate Power : 6000W	Model: 00F0-0980-0030-0900	SN: F00123456790	COM Addr: 1	FW: 510-012-109-1102
Menu Info																		
1. PV Info																		
2. AC Output Info																		
3. BAT Info																		
4. EPS Output Info																		
5. Basic Info																		
6. Energy Info																		
7. Fault Info																		
8. Setting Info																		
Basic Info																		
Date & Time : 22/08/23 11:40																		
Rate Power : 6000W																		
Model: 00F0-0980-0030-0900																		
SN: F00123456790																		
COM Addr: 1																		
FW: 510-012-109-1102																		

7.1.6 电能信息

显示逆变器日发电量和总发电量，电池日充电量和总充电量，电池日放电量和总发电量。

<table border="1" style="width: 100%; border-collapse: collapse;"> <tr><th style="text-align: center;">Menu Info</th></tr> <tr><td>1. PV Info</td></tr> <tr><td>2. AC Output Info</td></tr> <tr><td>3. BAT Info</td></tr> <tr><td>4. EPS Output Info</td></tr> <tr><td>5. Basic Info</td></tr> <tr style="background-color: black; color: white;"><td>6. Energy Info</td></tr> <tr><td>7. Fault Info</td></tr> <tr><td>8. Setting Info</td></tr> </table>	Menu Info	1. PV Info	2. AC Output Info	3. BAT Info	4. EPS Output Info	5. Basic Info	6. Energy Info	7. Fault Info	8. Setting Info	<p>→</p> <p>按“Enter”键进入电能信息页面</p> <p>←</p> <p>按“ESC”键退出电能信息页面</p>	<table border="1" style="width: 100%; border-collapse: collapse;"> <tr><th style="text-align: center;">Energy Info</th></tr> <tr><td>Energy Today: 23.5KWh</td></tr> <tr><td>Energy Total: 23.5KWh</td></tr> <tr><td>BAT Charge Today: 23.5KWh</td></tr> <tr><td>BAT Charge Total: 23.5KWh</td></tr> <tr><td>BAT Discharge Today: 23.5KWh</td></tr> <tr><td>BAT Discharge Total: 23.5KWh</td></tr> </table>	Energy Info	Energy Today: 23.5KWh	Energy Total: 23.5KWh	BAT Charge Today: 23.5KWh	BAT Charge Total: 23.5KWh	BAT Discharge Today: 23.5KWh	BAT Discharge Total: 23.5KWh
Menu Info																		
1. PV Info																		
2. AC Output Info																		
3. BAT Info																		
4. EPS Output Info																		
5. Basic Info																		
6. Energy Info																		
7. Fault Info																		
8. Setting Info																		
Energy Info																		
Energy Today: 23.5KWh																		
Energy Total: 23.5KWh																		
BAT Charge Today: 23.5KWh																		
BAT Charge Total: 23.5KWh																		
BAT Discharge Today: 23.5KWh																		
BAT Discharge Total: 23.5KWh																		

7.1.7 故障信息

显示总故障告警信息数和故障告警主码和子码，以及故障告警发生日期和时间。

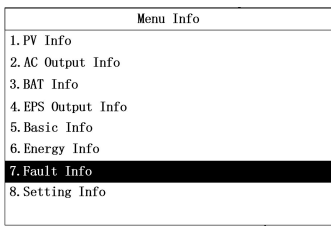
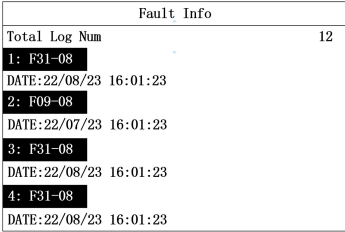
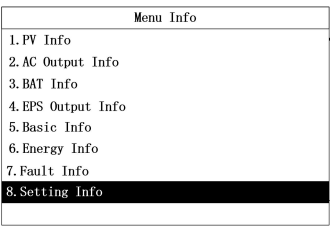
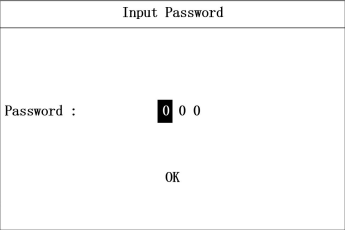
	<p style="text-align: center;">→</p> <p style="text-align: center;">按“Enter”键进入故障信息页面</p> <p style="text-align: center;">←</p> <p style="text-align: center;">按“ESC”键退出故障信息页面</p>	
	<p style="text-align: center;">→</p> <p style="text-align: center;">按“Enter”键进入故障信息页面</p> <p style="text-align: center;">←</p> <p style="text-align: center;">按“ESC”键退出故障信息页面</p>	

7.1.8 设置信息

进入设置页面需要输入密码。在“菜单”页面选择“设置页面”后，进入“输入密码”页面。
输入密码操作流程

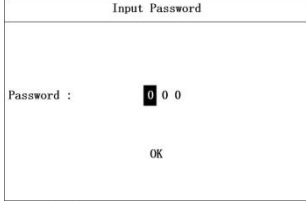
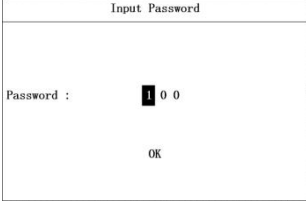
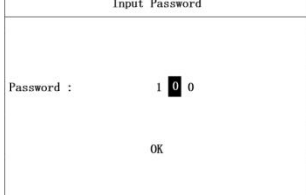
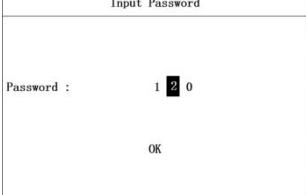
	<p style="text-align: center;">→</p> <p style="text-align: center;">按“向上”或“向下”键增加或减小数字</p>	
<p>▼ 按“确认”键</p>		
	<p style="text-align: center;">→</p> <p style="text-align: center;">按“向上”或“向下”键增加或减小数字</p>	

<p style="text-align: center;">▼ 按“确认”键</p> <div style="border: 1px solid black; padding: 5px;"> <p style="text-align: center;">Input Password</p> <hr/> <p>Password : 1 2 0</p> <p style="text-align: center;">OK</p> </div>	<p>→</p> <p>按“向上”或“向下”键增加或减小数字</p>	<div style="border: 1px solid black; padding: 5px;"> <p style="text-align: center;">Input Password</p> <hr/> <p>Password : 1 2 3</p> <p style="text-align: center;">OK</p> </div>
<p style="text-align: center;">▼ 按“确认”键</p> <div style="border: 1px solid black; padding: 5px;"> <p style="text-align: center;">Input Password</p> <hr/> <p>Password : 1 2 3</p> <p style="text-align: center;">OK</p> </div>	<p>→</p> <p>按“向上”或“向下”键增加或减小数字</p>	<div style="border: 1px solid black; padding: 5px;"> <p style="text-align: center;">Input Password</p> <hr/> <p>Password : 1 2 3</p> <p style="text-align: center;">Setting...</p> </div>
		<p>▼ 等待 3s</p> <div style="border: 1px solid black; padding: 5px;"> <p style="text-align: center;">Input Password</p> <hr/> <p>Password : 1 2 3</p> <p style="text-align: center;">Setting Ok!</p> </div>

7.2 设置信息页面

参数设置页面可设置逆变器日期和时间，通讯地址，语言，安规国家，优先级等参数。部分参数需要在待机情况下才被允许设置，屏幕面板的绿灯和黄灯在待机时不会保持常亮。设置页面显示如下图：

Setting Info
1. Date & Time Setting
2. COM Address Setting
3. Language Setting
4:BAT & Meter Setting
5. Country Setting
6. Off Grid Setting
7. Priority Setting
8. AutoTest Setting
9. Restore Factory Setting

7.2.1 日期和时间设置

<p>Setting Info</p> <ol style="list-style-type: none"> 1. Date & Time Setting 2. COM Address Setting 3. Language Setting 4. BAT & Meter Setting 5. Country Setting 6. Off Grid Setting 7. Priority Setting 8. AutoTest Setting 9. Restore Factory Setting 	<p style="text-align: center;">→</p> <p style="text-align: center;">按“确认”键</p>	<p>Date & Time Setting</p> <p>Day-Month-Year: 24 / 02 / 23</p> <p>Hour-Min-Sec: 19: 41 : 39</p> <p style="text-align: center;">OK</p>
<p>Date & Time Setting</p> <p>Day-Month-Year: 24 / 02 / 23</p> <p>Hour-Min-Sec: 19: 41 : 39</p> <p style="text-align: center;">OK</p>	<p style="text-align: center;">→</p> <p style="text-align: center;">按“向上”或“向下”键增加或减小数字</p>	<p>Date & Time Setting</p> <p>Day-Month-Year: 25 / 08 / 22</p> <p>Hour-Min-Sec: 19:41:39</p> <p style="text-align: center;">OK</p>
<p style="text-align: center;">▼ 按“确认”键</p>		
<p>Date & Time Setting</p> <p>Day-Month-Year: 25 / 08 / 22</p> <p>Hour-Min-Sec: 19:41:39</p> <p style="text-align: center;">OK</p>	<p style="text-align: center;">→</p> <p style="text-align: center;">按“向上”或“向下”键增加或减小数字</p>	<p>Date & Time Setting</p> <p>Day-Month-Year: 25 / 09 / 22</p> <p>Hour-Min-Sec: 19:41:39</p> <p style="text-align: center;">OK</p>
<p style="text-align: center;">▼ 按“确认”键</p>		
<p>Date & Time Setting</p> <p>Day-Month-Year: 25 / 08 / 22</p> <p>Hour-Min-Sec: 19:41:39</p> <p style="text-align: center;">OK</p>	<p style="text-align: center;">→</p> <p style="text-align: center;">按“向上”或“向下”键增加或减小数字</p>	<p>Date & Time Setting</p> <p>Day-Month-Year: 25 / 08 / 23</p> <p>Hour-Min-Sec: 19:41:39</p> <p style="text-align: center;">OK</p>
<p style="text-align: center;">▼ 按“确认”键</p>		

<p>Date & Time Setting</p> <p>Day-Month-Year: 25 / 08 / 22</p> <p>Hour-Min-Sec: 19:41:39</p> <p>OK</p>	<p>→</p> <p>按“向上”或“向下”键增加或减小数字</p>	<p>Date & Time Setting</p> <p>Day-Month-Year: 25 / 08 / 22</p> <p>Hour-Min-Sec: 20:41:39</p> <p>OK</p>
<p>▼ 按“确认”键</p>		
<p>Date & Time Setting</p> <p>Day-Month-Year: 25 / 08 / 22</p> <p>Hour-Min-Sec: 19:41:39</p> <p>OK</p>	<p>→</p> <p>按“向上”或“向下”键增加或减小数字</p>	<p>Date & Time Setting</p> <p>Day-Month-Year: 25 / 08 / 22</p> <p>Hour-Min-Sec: 19:42:39</p> <p>OK</p>
<p>▼ 按“确认”键</p>		
<p>Date & Time Setting</p> <p>Day-Month-Year: 25 / 08 / 22</p> <p>Hour-Min-Sec: 19:41:39</p> <p>OK</p>	<p>→</p> <p>按“向上”或“向下”键增加或减小数字</p>	<p>Date & Time Setting</p> <p>Day-Month-Year: 25 / 08 / 22</p> <p>Hour-Min-Sec: 19:41:40</p> <p>OK</p>
<p>按“确认”键</p>		
<p>Date & Time Setting</p> <p>Day-Month-Year: 25 / 08 / 22</p> <p>Hour-Min-Sec: 19:41:39</p> <p>OK</p>	<p>→</p> <p>按“确认”键</p>	<p>Date & Time Setting</p> <p>Day-Month-Year: 25 / 08 / 22</p> <p>Hour-Min-Sec: 19:41:39</p> <p>Setting...</p>
<p>▼ 等待 3S</p>		

		<p style="text-align: center;">Date & Time Setting</p> <hr/> <p>Day-Month-Year: 25 / 08 / 22 Hour-Min-Sec: 19:41:39</p> <p style="text-align: center;">Setting OK!</p>
--	--	--

7.2.2 通讯地址设置

<p style="text-align: center;">Setting Info</p> <ol style="list-style-type: none"> 1. Date & Time Setting <li style="background-color: black; color: white;">2. COM Address Setting 3. Language Setting 4. BAT & Meter Setting 5. Country Setting 6. Off Grid Setting 7. Priority Setting 8. AutoTest Setting 9. Restore Factory Setting 	<p>→</p> <p>按“确认”键</p>	<p style="text-align: center;">COM Address Setting</p> <hr/> <p>Address: 0 0 1</p> <p style="text-align: center;">OK</p>
<p style="text-align: center;">COM Address Setting</p> <hr/> <p>Address: 0 0 1</p> <p style="text-align: center;">OK</p>	<p>→</p> <p>按“向上”或“向下”键增加或减小数字</p>	<p style="text-align: center;">COM Address Setting</p> <hr/> <p>Address: 1 0 1</p> <p style="text-align: center;">OK</p>
<p>▼ 按“确认”键</p>		
<p style="text-align: center;">COM Address Setting</p> <hr/> <p>Address: 0 0 1</p> <p style="text-align: center;">OK</p>	<p>→</p> <p>按“向上”或“向下”键增加或减小数字</p>	<p style="text-align: center;">COM Address Setting</p> <hr/> <p>Address: 0 1 1</p> <p style="text-align: center;">OK</p>
<p>▼ 按“确认”键</p>		

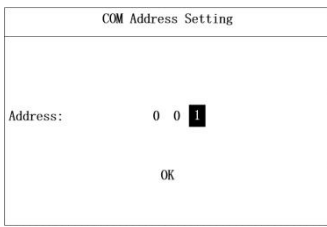
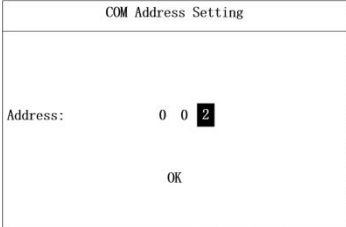
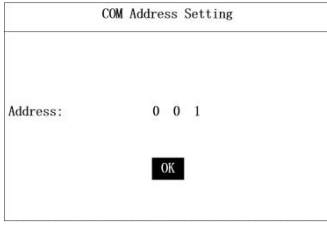
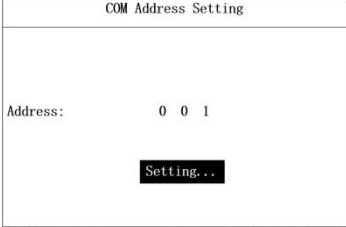
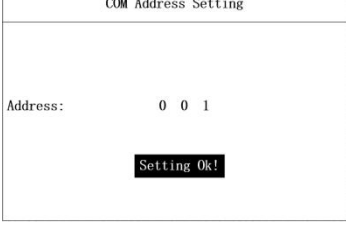
	<p style="text-align: center;">→</p> <p>按“向上”或“向下”键增加或减小数字</p>	
<p>▼ 按“确认”键</p>		
	<p style="text-align: center;">→</p> <p>按“确认”键</p>	
<p>▼ 等待 3S</p>		
		

7.2.3 语言设置

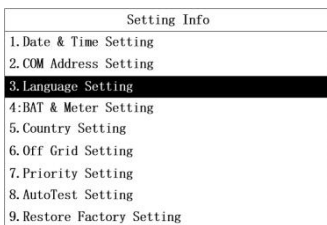
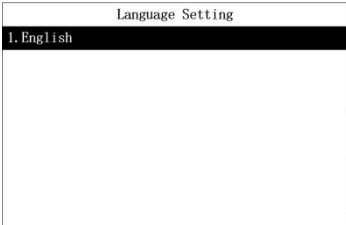
	<p style="text-align: center;">→</p> <p>按“确认”键</p>	

<div style="border: 1px solid black; padding: 5px;"> <p style="text-align: center;">Language Setting</p> <p>1. English</p> </div>	<p>→</p> <p>按“确认”键</p>	<div style="border: 1px solid black; padding: 5px;"> <p style="text-align: center;">Language Setting</p> <p>Language: English</p> <p style="text-align: center;">Setting..</p> </div>
		<p>▼ 等待 3S</p>
		<div style="border: 1px solid black; padding: 5px;"> <p style="text-align: center;">Language Setting</p> <p>Language: English</p> <p style="text-align: center;">Setting Ok!</p> </div>

7.2.4 电表设置

电池和电表设置页面可设置 CT 模式和电表厂商。设置流程如下：

<div style="border: 1px solid black; padding: 5px;"> <p style="text-align: center;">Setting Info</p> <ol style="list-style-type: none"> 1. Date & Time Setting 2. COM Address Setting 3. Language Setting <li style="background-color: black; color: white;">4. Bat & Meter Setting 5. Country Setting 6. Off Grid Setting 7. Priority Setting 8. AutoTest Setting 9. Restore Factory Setting </div>	<p>→</p> <p>按“确认”键</p>	<div style="border: 1px solid black; padding: 5px;"> <p style="text-align: center;">Bat & Meter Setting:</p> <p>Sensor: CT</p> <p>BAT Mfr: Lead-Acid</p> <p>CV: 58V</p> <p>CC: 60A</p> <p>LV: 48V</p> <p style="text-align: center;">OK</p> </div>
<div style="border: 1px solid black; padding: 5px;"> <p style="text-align: center;">Bat & Meter Setting:</p> <p>Sensor: CT</p> <p>BAT Mfr: Lead-Acid</p> <p>CV: 58V</p> <p>CC: 60A</p> <p>LV: 48V</p> <p style="text-align: center;">OK</p> </div>	<p>→</p> <p>按“向上”或“向下”键可以选择 CT 模式或者电表厂家</p>	<div style="border: 1px solid black; padding: 5px;"> <p style="text-align: center;">Bat & Meter Setting:</p> <p>Sensor: Eastron</p> <p>BAT Mfr: Lead-Acid</p> <p>CV: 58V</p> <p>CC: 60A</p> <p>LV: 48V</p> <p style="text-align: center;">OK</p> </div>
		<p>▼ 按“确认”键</p>





		<table border="1"> <tr><th colspan="2">Bat & Meter Setting:</th></tr> <tr><td>Sensor:</td><td>Eastron</td></tr> <tr><td>BAT Mfr:</td><td>Lead-Acid</td></tr> <tr><td>CV:</td><td>58V</td></tr> <tr><td>CC:</td><td>60A</td></tr> <tr><td>LV:</td><td>48V</td></tr> <tr><td colspan="2" style="text-align: center;">OK</td></tr> </table>	Bat & Meter Setting:		Sensor:	Eastron	BAT Mfr:	Lead-Acid	CV:	58V	CC:	60A	LV:	48V	OK	
Bat & Meter Setting:																
Sensor:	Eastron															
BAT Mfr:	Lead-Acid															
CV:	58V															
CC:	60A															
LV:	48V															
OK																
		▼ 按“确认”键														
		<table border="1"> <tr><th colspan="2">Bat & Meter Setting:</th></tr> <tr><td>Sensor:</td><td>Eastron</td></tr> <tr><td>BAT Mfr:</td><td>Lead-Acid</td></tr> <tr><td>CV:</td><td>58V</td></tr> <tr><td>CC:</td><td>60A</td></tr> <tr><td>LV:</td><td>48V</td></tr> <tr><td colspan="2" style="text-align: center;">Setting...</td></tr> </table>	Bat & Meter Setting:		Sensor:	Eastron	BAT Mfr:	Lead-Acid	CV:	58V	CC:	60A	LV:	48V	Setting...	
Bat & Meter Setting:																
Sensor:	Eastron															
BAT Mfr:	Lead-Acid															
CV:	58V															
CC:	60A															
LV:	48V															
Setting...																
		▼ 按“确认”键														
		<table border="1"> <tr><th colspan="2">Bat & Meter Setting:</th></tr> <tr><td>Sensor:</td><td>Eastron</td></tr> <tr><td>BAT Mfr:</td><td>Lead-Acid</td></tr> <tr><td>CV:</td><td>58V</td></tr> <tr><td>CC:</td><td>60A</td></tr> <tr><td>LV:</td><td>48V</td></tr> <tr><td colspan="2" style="text-align: center;">Setting Ok!</td></tr> </table>	Bat & Meter Setting:		Sensor:	Eastron	BAT Mfr:	Lead-Acid	CV:	58V	CC:	60A	LV:	48V	Setting Ok!	
Bat & Meter Setting:																
Sensor:	Eastron															
BAT Mfr:	Lead-Acid															
CV:	58V															
CC:	60A															
LV:	48V															
Setting Ok!																

7.2.5 电池参数设置

电池和电表设置页面显示的内容根据电池厂商显示相应的参数。若是铅酸电池，则可设置的电池参数为 LV, HV, Charge Curr 和 Discharge Curr。若为锂电池厂商，则可设置的电池参数为最大充电电流，最大放电电流，DOD（电池放电深度）和 BatWakeUp（电池唤醒功能，使能后 5 分钟自动失能）。如下是铅酸电池参数设置流程：

<table border="1"> <tr><th colspan="2">Setting Info</th></tr> <tr><td>1.Date & Time Setting</td></tr> <tr><td>2.COM Address Setting</td></tr> <tr><td>3.Language Setting</td></tr> <tr><td>4:Bat & Meter Setting</td></tr> <tr><td>5.Country Setting</td></tr> <tr><td>6.Off Grid Setting</td></tr> <tr><td>7.Priority Setting</td></tr> <tr><td>8.AutoTest Setting</td></tr> <tr><td>9.Restore Factory Setting</td></tr> </table>	Setting Info		1.Date & Time Setting	2.COM Address Setting	3.Language Setting	4:Bat & Meter Setting	5.Country Setting	6.Off Grid Setting	7.Priority Setting	8.AutoTest Setting	9.Restore Factory Setting	<p>→</p> <p>按“确认”键</p>	<table border="1"> <tr><th colspan="2">Bat & Meter Setting:</th></tr> <tr><td>Sensor:</td><td>CT</td></tr> <tr><td>BAT Type:</td><td>Lead-Acid</td></tr> <tr><td>LV:</td><td>59V</td></tr> <tr><td>HV:</td><td>61V</td></tr> <tr><td>Charge Curr:</td><td>47A</td></tr> <tr><td>DisCharge Curr:</td><td>48A</td></tr> <tr><td colspan="2" style="text-align: center;">OK</td></tr> </table>	Bat & Meter Setting:		Sensor:	CT	BAT Type:	Lead-Acid	LV:	59V	HV:	61V	Charge Curr:	47A	DisCharge Curr:	48A	OK	
Setting Info																													
1.Date & Time Setting																													
2.COM Address Setting																													
3.Language Setting																													
4:Bat & Meter Setting																													
5.Country Setting																													
6.Off Grid Setting																													
7.Priority Setting																													
8.AutoTest Setting																													
9.Restore Factory Setting																													
Bat & Meter Setting:																													
Sensor:	CT																												
BAT Type:	Lead-Acid																												
LV:	59V																												
HV:	61V																												
Charge Curr:	47A																												
DisCharge Curr:	48A																												
OK																													

<table border="1"> <thead> <tr> <th colspan="2">Bat & Meter Setting:</th> </tr> </thead> <tbody> <tr> <td>Sensor:</td> <td>CT</td> </tr> <tr> <td>BAT Type:</td> <td>Load-Acid</td> </tr> <tr> <td>LV:</td> <td>59V</td> </tr> <tr> <td>HV:</td> <td>61V</td> </tr> <tr> <td>Charge Curr:</td> <td>47A</td> </tr> <tr> <td>DisCharge Curr:</td> <td>48A</td> </tr> <tr> <td colspan="2" style="text-align: center;">OK</td> </tr> </tbody> </table>	Bat & Meter Setting:		Sensor:	CT	BAT Type:	Load-Acid	LV:	59V	HV:	61V	Charge Curr:	47A	DisCharge Curr:	48A	OK		<p style="text-align: center;">→</p> <p>按“向上”或者“向下”键可选择铅酸电池或者锂电池厂家</p>	<table border="1"> <thead> <tr> <th colspan="2">Bat & Meter Setting:</th> </tr> </thead> <tbody> <tr> <td>Sensor:</td> <td>CT</td> </tr> <tr> <td>BAT Type:</td> <td>ATL</td> </tr> <tr> <td>LV:</td> <td>59V</td> </tr> <tr> <td>HV:</td> <td>61V</td> </tr> <tr> <td>Charge Curr:</td> <td>47A</td> </tr> <tr> <td>DisCharge Curr:</td> <td>48A</td> </tr> <tr> <td colspan="2" style="text-align: center;">OK</td> </tr> </tbody> </table>	Bat & Meter Setting:		Sensor:	CT	BAT Type:	ATL	LV:	59V	HV:	61V	Charge Curr:	47A	DisCharge Curr:	48A	OK	
Bat & Meter Setting:																																		
Sensor:	CT																																	
BAT Type:	Load-Acid																																	
LV:	59V																																	
HV:	61V																																	
Charge Curr:	47A																																	
DisCharge Curr:	48A																																	
OK																																		
Bat & Meter Setting:																																		
Sensor:	CT																																	
BAT Type:	ATL																																	
LV:	59V																																	
HV:	61V																																	
Charge Curr:	47A																																	
DisCharge Curr:	48A																																	
OK																																		
<p>▼ 按“确认”键</p>																																		
<table border="1"> <thead> <tr> <th colspan="2">Bat & Meter Setting:</th> </tr> </thead> <tbody> <tr> <td>Sensor:</td> <td>CT</td> </tr> <tr> <td>BAT Type:</td> <td>ATL</td> </tr> <tr> <td>LV:</td> <td>58V</td> </tr> <tr> <td>HV:</td> <td>61V</td> </tr> <tr> <td>Charge Curr:</td> <td>47A</td> </tr> <tr> <td>DisCharge Curr:</td> <td>48A</td> </tr> <tr> <td colspan="2" style="text-align: center;">OK</td> </tr> </tbody> </table>	Bat & Meter Setting:		Sensor:	CT	BAT Type:	ATL	LV:	58V	HV:	61V	Charge Curr:	47A	DisCharge Curr:	48A	OK		<p style="text-align: center;">→</p> <p>按“向上”或者“向下”键可增加或者减小LV最小放电电压</p>	<table border="1"> <thead> <tr> <th colspan="2">Bat & Meter Setting:</th> </tr> </thead> <tbody> <tr> <td>Sensor:</td> <td>CT</td> </tr> <tr> <td>BAT Type:</td> <td>ATL</td> </tr> <tr> <td>LV:</td> <td>59V</td> </tr> <tr> <td>HV:</td> <td>61V</td> </tr> <tr> <td>Charge Curr:</td> <td>47A</td> </tr> <tr> <td>DisCharge Curr:</td> <td>48A</td> </tr> <tr> <td colspan="2" style="text-align: center;">OK</td> </tr> </tbody> </table>	Bat & Meter Setting:		Sensor:	CT	BAT Type:	ATL	LV:	59V	HV:	61V	Charge Curr:	47A	DisCharge Curr:	48A	OK	
Bat & Meter Setting:																																		
Sensor:	CT																																	
BAT Type:	ATL																																	
LV:	58V																																	
HV:	61V																																	
Charge Curr:	47A																																	
DisCharge Curr:	48A																																	
OK																																		
Bat & Meter Setting:																																		
Sensor:	CT																																	
BAT Type:	ATL																																	
LV:	59V																																	
HV:	61V																																	
Charge Curr:	47A																																	
DisCharge Curr:	48A																																	
OK																																		
<p>▼ 按“确认”键</p>																																		
<table border="1"> <thead> <tr> <th colspan="2">Bat & Meter Setting:</th> </tr> </thead> <tbody> <tr> <td>Sensor:</td> <td>CT</td> </tr> <tr> <td>BAT Type:</td> <td>ATL</td> </tr> <tr> <td>LV:</td> <td>59V</td> </tr> <tr> <td>HV:</td> <td>60V</td> </tr> <tr> <td>Charge Curr:</td> <td>47A</td> </tr> <tr> <td>DisCharge Curr:</td> <td>48A</td> </tr> <tr> <td colspan="2" style="text-align: center;">OK</td> </tr> </tbody> </table>	Bat & Meter Setting:		Sensor:	CT	BAT Type:	ATL	LV:	59V	HV:	60V	Charge Curr:	47A	DisCharge Curr:	48A	OK		<p style="text-align: center;">→</p> <p>按“向上”或者“向下”键可增加或者减小HV最大充电电压</p>	<table border="1"> <thead> <tr> <th colspan="2">Bat & Meter Setting:</th> </tr> </thead> <tbody> <tr> <td>Sensor:</td> <td>CT</td> </tr> <tr> <td>BAT Type:</td> <td>ATL</td> </tr> <tr> <td>LV:</td> <td>59V</td> </tr> <tr> <td>HV:</td> <td>61V</td> </tr> <tr> <td>Charge Curr:</td> <td>47A</td> </tr> <tr> <td>DisCharge Curr:</td> <td>48A</td> </tr> <tr> <td colspan="2" style="text-align: center;">OK</td> </tr> </tbody> </table>	Bat & Meter Setting:		Sensor:	CT	BAT Type:	ATL	LV:	59V	HV:	61V	Charge Curr:	47A	DisCharge Curr:	48A	OK	
Bat & Meter Setting:																																		
Sensor:	CT																																	
BAT Type:	ATL																																	
LV:	59V																																	
HV:	60V																																	
Charge Curr:	47A																																	
DisCharge Curr:	48A																																	
OK																																		
Bat & Meter Setting:																																		
Sensor:	CT																																	
BAT Type:	ATL																																	
LV:	59V																																	
HV:	61V																																	
Charge Curr:	47A																																	
DisCharge Curr:	48A																																	
OK																																		
<p>▼ 按“确认”键</p>																																		
<table border="1"> <thead> <tr> <th colspan="2">Bat & Meter Setting:</th> </tr> </thead> <tbody> <tr> <td>Sensor:</td> <td>CT</td> </tr> <tr> <td>BAT Type:</td> <td>ATL</td> </tr> <tr> <td>LV:</td> <td>59V</td> </tr> <tr> <td>HV:</td> <td>61V</td> </tr> <tr> <td>Charge Curr:</td> <td>47A</td> </tr> <tr> <td>DisCharge Curr:</td> <td>48A</td> </tr> <tr> <td colspan="2" style="text-align: center;">OK</td> </tr> </tbody> </table>	Bat & Meter Setting:		Sensor:	CT	BAT Type:	ATL	LV:	59V	HV:	61V	Charge Curr:	47A	DisCharge Curr:	48A	OK		<p style="text-align: center;">→</p> <p>按“向上”或者“向下”键可增加或者减小充电电流值，放电电流原理相同，不再阐述。</p>	<table border="1"> <thead> <tr> <th colspan="2">Bat & Meter Setting:</th> </tr> </thead> <tbody> <tr> <td>Sensor:</td> <td>CT</td> </tr> <tr> <td>BAT Type:</td> <td>ATL</td> </tr> <tr> <td>LV:</td> <td>59V</td> </tr> <tr> <td>HV:</td> <td>61V</td> </tr> <tr> <td>Charge Curr:</td> <td>48A</td> </tr> <tr> <td>DisCharge Curr:</td> <td>48A</td> </tr> <tr> <td colspan="2" style="text-align: center;">OK</td> </tr> </tbody> </table>	Bat & Meter Setting:		Sensor:	CT	BAT Type:	ATL	LV:	59V	HV:	61V	Charge Curr:	48A	DisCharge Curr:	48A	OK	
Bat & Meter Setting:																																		
Sensor:	CT																																	
BAT Type:	ATL																																	
LV:	59V																																	
HV:	61V																																	
Charge Curr:	47A																																	
DisCharge Curr:	48A																																	
OK																																		
Bat & Meter Setting:																																		
Sensor:	CT																																	
BAT Type:	ATL																																	
LV:	59V																																	
HV:	61V																																	
Charge Curr:	48A																																	
DisCharge Curr:	48A																																	
OK																																		

 按“确认”键		
 按“确认”键		
 按“确认”键		 按“确认”键

Bat & Meter Setting:

Sensor:	CT
BAT Type:	ATL
LV:	59V
HV:	61V
Charge Curr:	48A
DisCharge Curr:	48A

OK

Bat & Meter Setting:

Sensor:	CT
BAT Type:	ATL
LV:	59V
HV:	61V
Charge Curr:	48A
DisCharge Curr:	48A





Setting...

Bat & Meter Setting:

Sensor:	CT
BAT Type:	ATL
LV:	59V
HV:	61V
Charge Curr:	48A
DisCharge Curr:	48A

Setting OK!

如下是锂电池参数设置流程：

 按“确认”键		
 按“确认”键		
 按“确认”键		 按“确认”键

Setting Info

1. Date & Time Setting
2. COM Address Setting
3. Language Setting
4. Bat & Meter Setting
5. Country Setting
6. Off Grid Setting
7. Priority Setting
8. AutoTest Setting
9. Restore Factory Setting

Bat & Meter Setting

Sensor:	CT
BAT Type:	ATL
Charge Curr:	60A
Discharge Curr:	60A
DOD:	90%
BatWakeup:	Disable

OK

Bat & Meter Setting



Sensor:	CT
BAT Type:	ATL
Charge Curr:	60A
Discharge Curr:	60A
DOD:	90%
BatWakeup:	Disable

OK

Bat & Meter Setting

Sensor:	CT
BAT Type:	VestWoods
Charge Curr:	60A
Discharge Curr:	60A
DOD:	90%
BatWakeup:	Disable

OK

<table border="1" style="width: 100%; border-collapse: collapse;"> <tr><th colspan="2" style="text-align: center;">Bat & Meter Setting</th></tr> <tr><td>Sensor:</td><td style="text-align: right;">CT</td></tr> <tr><td>BAT Type:</td><td style="text-align: right;">VestWoods</td></tr> <tr style="background-color: #f0f0f0;"><td>Charge Curr:</td><td style="text-align: right;">60A</td></tr> <tr><td>Discharge Curr:</td><td style="text-align: right;">60A</td></tr> <tr><td>DOD:</td><td style="text-align: right;">90%</td></tr> <tr><td>BatWakeUp:</td><td style="text-align: right;">Disable</td></tr> <tr><td colspan="2" style="text-align: center; padding-top: 20px;">OK</td></tr> </table>	Bat & Meter Setting		Sensor:	CT	BAT Type:	VestWoods	Charge Curr:	60A	Discharge Curr:	60A	DOD:	90%	BatWakeUp:	Disable	OK		 按“向上”或者 “向下”键可增加和减少最大充电电流值	<table border="1" style="width: 100%; border-collapse: collapse;"> <tr><th colspan="2" style="text-align: center;">Bat & Meter Setting</th></tr> <tr><td>Sensor:</td><td style="text-align: right;">CT</td></tr> <tr><td>BAT Type:</td><td style="text-align: right;">VestWoods</td></tr> <tr style="background-color: #f0f0f0;"><td>Charge Curr:</td><td style="text-align: right;">61A</td></tr> <tr><td>Discharge Curr:</td><td style="text-align: right;">60A</td></tr> <tr><td>DOD:</td><td style="text-align: right;">90%</td></tr> <tr><td>BatWakeUp:</td><td style="text-align: right;">Disable</td></tr> <tr><td colspan="2" style="text-align: center; padding-top: 20px;">OK</td></tr> </table>	Bat & Meter Setting		Sensor:	CT	BAT Type:	VestWoods	Charge Curr:	61A	Discharge Curr:	60A	DOD:	90%	BatWakeUp:	Disable	OK	
Bat & Meter Setting																																		
Sensor:	CT																																	
BAT Type:	VestWoods																																	
Charge Curr:	60A																																	
Discharge Curr:	60A																																	
DOD:	90%																																	
BatWakeUp:	Disable																																	
OK																																		
Bat & Meter Setting																																		
Sensor:	CT																																	
BAT Type:	VestWoods																																	
Charge Curr:	61A																																	
Discharge Curr:	60A																																	
DOD:	90%																																	
BatWakeUp:	Disable																																	
OK																																		
<table border="1" style="width: 100%; border-collapse: collapse;"> <tr><th colspan="2" style="text-align: center;">Bat & Meter Setting</th></tr> <tr><td>Sensor:</td><td style="text-align: right;">CT</td></tr> <tr><td>BAT Type:</td><td style="text-align: right;">VestWoods</td></tr> <tr><td>Charge Curr:</td><td style="text-align: right;">61A</td></tr> <tr style="background-color: #f0f0f0;"><td>Discharge Curr:</td><td style="text-align: right;">60A</td></tr> <tr><td>DOD:</td><td style="text-align: right;">90%</td></tr> <tr><td>BatWakeUp:</td><td style="text-align: right;">Disable</td></tr> <tr><td colspan="2" style="text-align: center; padding-top: 20px;">OK</td></tr> </table>	Bat & Meter Setting		Sensor:	CT	BAT Type:	VestWoods	Charge Curr:	61A	Discharge Curr:	60A	DOD:	90%	BatWakeUp:	Disable	OK		 按“向上”或者 “向下”键可增加和减少最大放电电流值，DOD和 BatWakeUp 同理，不再阐述。	<table border="1" style="width: 100%; border-collapse: collapse;"> <tr><th colspan="2" style="text-align: center;">Bat & Meter Setting</th></tr> <tr><td>Sensor:</td><td style="text-align: right;">CT</td></tr> <tr><td>BAT Type:</td><td style="text-align: right;">VestWoods</td></tr> <tr><td>Charge Curr:</td><td style="text-align: right;">61A</td></tr> <tr style="background-color: #f0f0f0;"><td>Discharge Curr:</td><td style="text-align: right;">61A</td></tr> <tr><td>DOD:</td><td style="text-align: right;">90%</td></tr> <tr><td>BatWakeUp:</td><td style="text-align: right;">Disable</td></tr> <tr><td colspan="2" style="text-align: center; padding-top: 20px;">OK</td></tr> </table>	Bat & Meter Setting		Sensor:	CT	BAT Type:	VestWoods	Charge Curr:	61A	Discharge Curr:	61A	DOD:	90%	BatWakeUp:	Disable	OK	
Bat & Meter Setting																																		
Sensor:	CT																																	
BAT Type:	VestWoods																																	
Charge Curr:	61A																																	
Discharge Curr:	60A																																	
DOD:	90%																																	
BatWakeUp:	Disable																																	
OK																																		
Bat & Meter Setting																																		
Sensor:	CT																																	
BAT Type:	VestWoods																																	
Charge Curr:	61A																																	
Discharge Curr:	61A																																	
DOD:	90%																																	
BatWakeUp:	Disable																																	
OK																																		
		▼ 按“确认”键																																
		<table border="1" style="width: 100%; border-collapse: collapse;"> <tr><th colspan="2" style="text-align: center;">Bat & Meter Setting</th></tr> <tr><td>Sensor:</td><td style="text-align: right;">CT</td></tr> <tr><td>BAT Type:</td><td style="text-align: right;">VestWoods</td></tr> <tr><td>Charge Curr:</td><td style="text-align: right;">61A</td></tr> <tr><td>Discharge Curr:</td><td style="text-align: right;">61A</td></tr> <tr><td>DOD:</td><td style="text-align: right;">90%</td></tr> <tr><td>BatWakeUp:</td><td style="text-align: right;">Disable</td></tr> <tr><td colspan="2" style="text-align: center; padding-top: 20px;">OK</td></tr> </table>	Bat & Meter Setting		Sensor:	CT	BAT Type:	VestWoods	Charge Curr:	61A	Discharge Curr:	61A	DOD:	90%	BatWakeUp:	Disable	OK																	
Bat & Meter Setting																																		
Sensor:	CT																																	
BAT Type:	VestWoods																																	
Charge Curr:	61A																																	
Discharge Curr:	61A																																	
DOD:	90%																																	
BatWakeUp:	Disable																																	
OK																																		
		▼ 按“确认”键																																
		<table border="1" style="width: 100%; border-collapse: collapse;"> <tr><th colspan="2" style="text-align: center;">Bat & Meter Setting</th></tr> <tr><td>Sensor:</td><td style="text-align: right;">CT</td></tr> <tr><td>BAT Type:</td><td style="text-align: right;">VestWoods</td></tr> <tr><td>Charge Curr:</td><td style="text-align: right;">61A</td></tr> <tr><td>Discharge Curr:</td><td style="text-align: right;">61A</td></tr> <tr><td>DOD:</td><td style="text-align: right;">90%</td></tr> <tr><td>BatWakeUp:</td><td style="text-align: right;">Disable</td></tr> <tr><td colspan="2" style="text-align: center; padding-top: 20px;">Setting</td></tr> </table>	Bat & Meter Setting		Sensor:	CT	BAT Type:	VestWoods	Charge Curr:	61A	Discharge Curr:	61A	DOD:	90%	BatWakeUp:	Disable	Setting																	
Bat & Meter Setting																																		
Sensor:	CT																																	
BAT Type:	VestWoods																																	
Charge Curr:	61A																																	
Discharge Curr:	61A																																	
DOD:	90%																																	
BatWakeUp:	Disable																																	
Setting																																		
		▼ 等待 3S																																

		<div style="border: 1px solid black; padding: 5px;"> <p style="text-align: center;">Bat & Meter Setting</p> <p>Sensor: CT BAT Type: VestWoods Charge Curr: 61A Discharge Curr: 61A DOD: 90% BatWakeup: Disable</p> <p style="text-align: center; background-color: black; color: white; padding: 2px;">Setting OK!</p> </div>
--	--	--

7.2.6 国家安规设置

<div style="border: 1px solid black; padding: 5px;"> <p style="text-align: center;">Setting Info</p> <p>1.Date & Time Setting 2.COM Address Setting 3.Language Setting 4:BAT & Meter Setting 5.Country Setting 6.Off Grid Setting 7.Priority Setting 8.AutoTest Setting 9.Restore Factory Setting</p> </div>	<p>→</p> <p>按“确认”键</p>	<div style="border: 1px solid black; padding: 5px;"> <p style="text-align: center;">Country Setting 1/2</p> <p>1.CQC2013 2.SKYWORTH 3.EN50549 4.ITALY 5.SPAIN 6.NRS 7.HUNARY 8.BELGAIN 9.AUSTRALIAN WEST</p> </div>
<div style="border: 1px solid black; padding: 5px;"> <p style="text-align: center;">Country Setting 1/2</p> <p>1.CQC2013 2.SKYWORTH 3.EN50549 4.ITALY 5.SPAIN 6.NRS 7.HUNARY 8.BELGAIN 9.AUSTRALIAN WEST</p> </div>	<p>→</p> <p>按“向上”或者 “向下”键可选 择安规国家</p>	<div style="border: 1px solid black; padding: 5px;"> <p style="text-align: center;">Country Setting 1/2</p> <p>1.CQC2013 2.SKYWORTH 3.EN50549 4.ITALY 5.SPAIN 6.NRS 7.HUNARY 8.BELGAIN 9.AUSTRALIAN WEST</p> </div>
		<p>▼ 按“确认”键</p>
		<div style="border: 1px solid black; padding: 5px;"> <p style="text-align: center;">Country Setting</p> <p>Country: EN50549</p> <p style="text-align: center; background-color: black; color: white; padding: 2px;">Setting...</p> </div>
		<p>▼ 等待 3S</p>

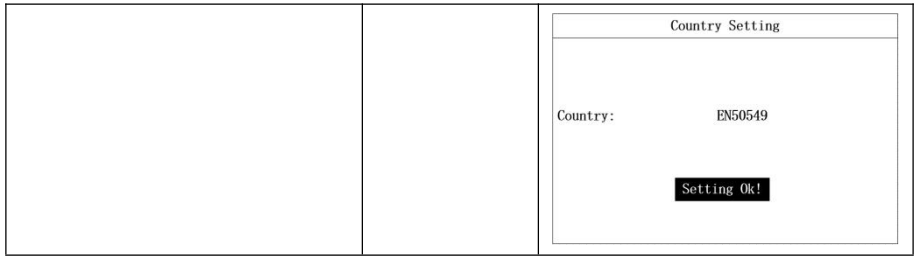

7.2.7 离网设置

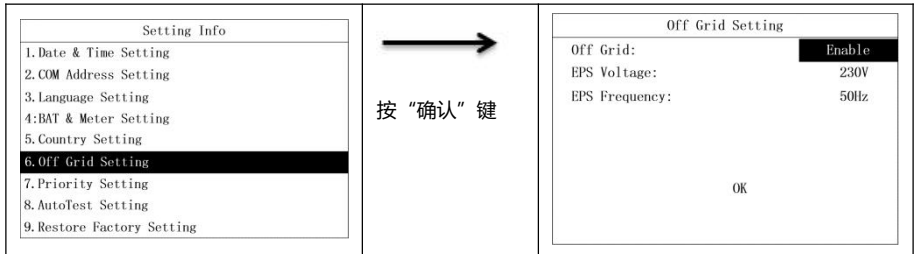



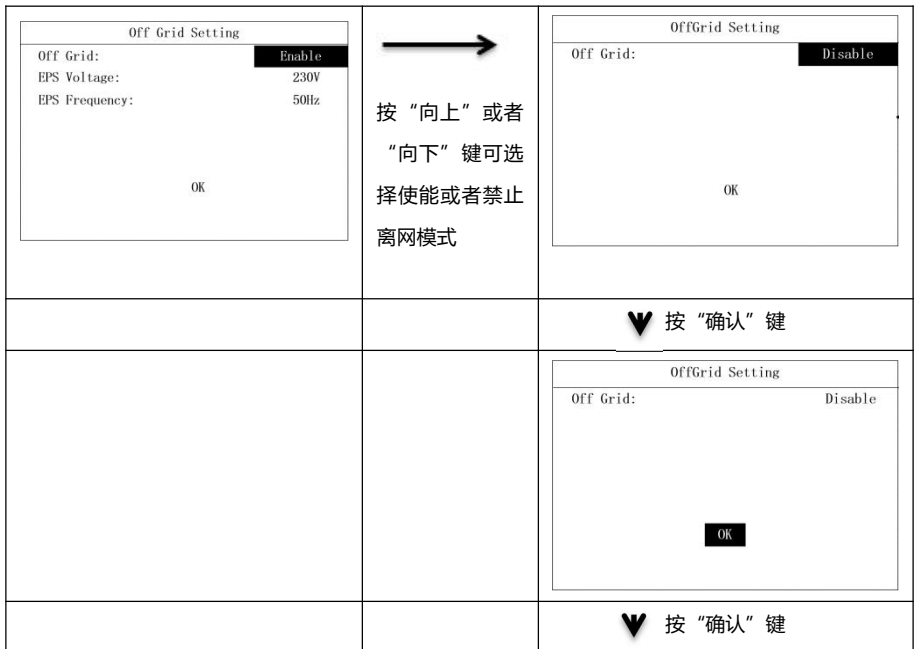

如下流程为设置禁止离网模式：

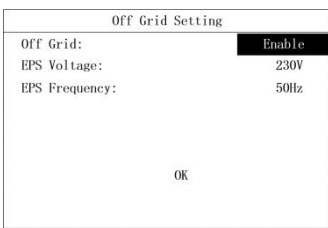

		
		▼ 等待 3S
		

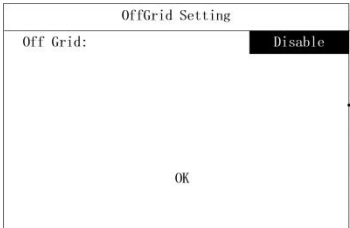
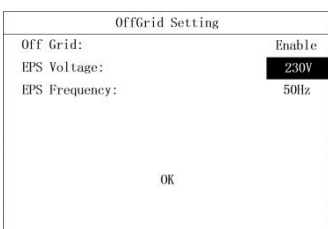
如下流程为设置使能离网模式和离网电压，频率参数流程：

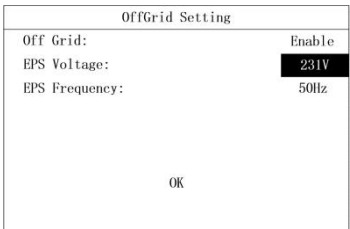
		
	按“向上”或者 “向下”键可选 择使能或者禁止 离网模式	
▼ 按“确认”键		
		
	按“向上”或者 “向下”键可增 加或者减少离网 电压值	
▼ 按“确认”键		

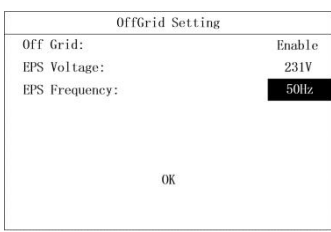
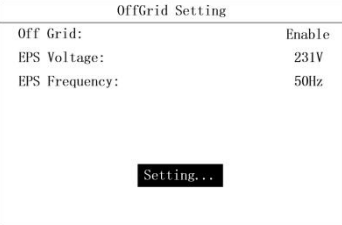
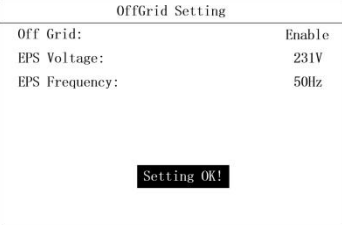



	<p style="text-align: center;">→</p> <p>按“向上”或者“向下”键可增加或者减少离网频率值</p>	
<p style="text-align: center;">▼ 按“确认”键</p>		
	<p style="text-align: center;">→</p> <p>按“确认”键</p>	
		<p style="text-align: center;">▼ 按“确认”键</p>
		

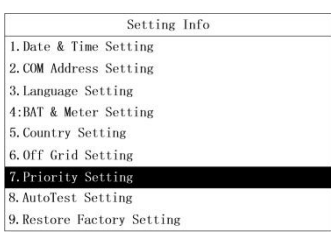
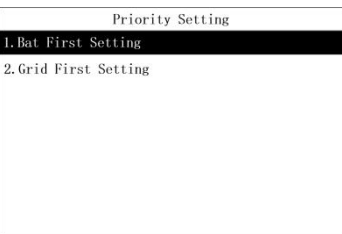

7.2.8 优先级设置

优先级设置包含电池优先和电网优先两种模式的参数设置。

	<p style="text-align: center;">→</p> <p>按“确认”键</p>	
---	--	---

如下是电池优先模式参数设置流程：





<p style="text-align: center;">Priority Setting</p> <p>1. Bat First Setting</p> <p>2. Grid First Setting</p>	 按“确认”键	<p style="text-align: center;">Bat First Setting</p> <p>AC Charge: Enable</p> <p>Time Interval: 1</p> <p>Time Active: Enable</p> <p>Time: 01:00 - 05:00</p> <p>Stop Charge SOC: 50%</p> <p>Charge Power: 50%</p> <p style="text-align: center;">OK</p>
<p style="text-align: center;">Bat First Setting</p> <p>AC Charge: Enable</p> <p>Time Interval: 1</p> <p>Time Active: Enable</p> <p>Time: 01:00 - 05:00</p> <p>Stop Charge SOC: 50%</p> <p>Charge Power: 50%</p> <p style="text-align: center;">OK</p>	 “向上”或者“向下”键可选择使能或者禁止电网充电功能	<p style="text-align: center;">Bat First Setting</p> <p>AC Charge: Disable</p> <p>Time Interval: 1</p> <p>Time Active: Enable</p> <p>Time: 01:00 - 05:00</p> <p>Stop Charge SOC: 50%</p> <p>Charge Power: 50%</p> <p style="text-align: center;">OK</p>
<p>▼ 按“确认”键</p>		
<p style="text-align: center;">Bat First Setting</p> <p>AC Charge: Disable</p> <p>Time Interval: 1</p> <p>Time Active: Enable</p> <p>Time: 01:00 - 05:00</p> <p>Stop Charge SOC: 50%</p> <p>Charge Power: 50%</p> <p style="text-align: center;">OK</p>	 “向上”或者“向下”键可选择时间段	<p style="text-align: center;">Bat First Setting</p> <p>AC Charge: Disable</p> <p>Time Interval: 2</p> <p>Time Active: Enable</p> <p>Time: 01:00 - 05:00</p> <p>Stop Charge SOC: 50%</p> <p>Charge Power: 50%</p> <p style="text-align: center;">OK</p>
<p>▼ 按“确认”键</p>		
<p style="text-align: center;">Bat First Setting</p> <p>AC Charge: Disable</p> <p>Time Interval: 1</p> <p>Time Active: Enable</p> <p>Time: 01:00 - 05:00</p> <p>Stop Charge SOC: 50%</p> <p>Charge Power: 50%</p> <p style="text-align: center;">OK</p>	 按“向上”或者“向下”键可选择使能或者禁止时间段	<p style="text-align: center;">Bat First Setting</p> <p>AC Charge: Disable</p> <p>Time Interval: 1</p> <p>Time Active: Disable</p> <p>Time: 01:00 - 05:00</p> <p>Stop Charge SOC: 50%</p> <p>Charge Power: 50%</p> <p style="text-align: center;">OK</p>
<p>▼ 按“确认”键</p>		

<div style="border: 1px solid black; padding: 5px;"> <p style="text-align: center;">Bat First Setting</p> <p>AC Charge: Disable</p> <p>Time Interval: 1</p> <p>Time Active: Enable</p> <p>Time: 01:00 - 05:00</p> <p>Stop Charge SOC: 50%</p> <p>Charge Power: 50%</p> <p style="text-align: center;">OK</p> </div>	 <p>按“向上”或者 “向下”键可增 加或者减少时间 数值</p>	<div style="border: 1px solid black; padding: 5px;"> <p style="text-align: center;">Bat First Setting</p> <p>AC Charge: Disable</p> <p>Time Interval: 1</p> <p>Time Active: Enable</p> <p>Time: 02:00 - 05:00</p> <p>Stop Charge SOC: 50%</p> <p>Charge Power: 50%</p> <p style="text-align: center;">OK</p> </div>
<p>▼ 按“确认”键</p>		
<div style="border: 1px solid black; padding: 5px;"> <p style="text-align: center;">Bat First Setting</p> <p>AC Charge: Disable</p> <p>Time Interval: 1</p> <p>Time Active: Enable</p> <p>Time: 01:00 - 05:00</p> <p>Stop Charge SOC: 50%</p> <p>Charge Power: 50%</p> <p style="text-align: center;">OK</p> </div>	 <p>按“向上”或者 “向下”键可增 加或者减少停止 充电 SOC</p>	<div style="border: 1px solid black; padding: 5px;"> <p style="text-align: center;">Bat First Setting</p> <p>AC Charge: Disable</p> <p>Time Interval: 1</p> <p>Time Active: Enable</p> <p>Time: 01:00 - 05:00</p> <p>Stop Charge SOC: 51%</p> <p>Charge Power: 50%</p> <p style="text-align: center;">OK</p> </div>
<p>▼ 按“确认”键</p>		
<div style="border: 1px solid black; padding: 5px;"> <p style="text-align: center;">Bat First Setting</p> <p>AC Charge: Disable</p> <p>Time Interval: 1</p> <p>Time Active: Enable</p> <p>Time: 01:00 - 05:00</p> <p>Stop Charge SOC: 50%</p> <p>Charge Power: 50%</p> <p style="text-align: center;">OK</p> </div>	 <p>按“向上”或者 “向下”键可增 加或者减少充电 功率百分比</p>	<div style="border: 1px solid black; padding: 5px;"> <p style="text-align: center;">Bat First Setting</p> <p>AC Charge: Disable</p> <p>Time Interval: 1</p> <p>Time Active: Enable</p> <p>Time: 01:00 - 05:00</p> <p>Stop Charge SOC: 50%</p> <p>Charge Power: 51%</p> <p style="text-align: center;">OK</p> </div>
<p>▼ 按“确认”键</p>		
<div style="border: 1px solid black; padding: 5px;"> <p style="text-align: center;">Bat First Setting</p> <p>AC Charge: Disable</p> <p>Time Interval: 1</p> <p>Time Active: Enable</p> <p>Time: 01:00 - 05:00</p> <p>Stop Charge SOC: 50%</p> <p>Charge Power: 50%</p> <p style="text-align: center;">OK</p> </div>	 <p>按“确认”键</p>	<div style="border: 1px solid black; padding: 5px;"> <p style="text-align: center;">Bat First Setting</p> <p>AC Charge: Disable</p> <p>Time Interval: 1</p> <p>Time Active: Enable</p> <p>Time: 01:00 - 05:00</p> <p>Stop Charge SOC: 50%</p> <p>Charge Power: 50%</p> <p style="text-align: center;">Setting...</p> </div>
<p>▼ 等待 3S</p>		

		<table border="1"> <tr> <th colspan="2">Bat First Setting</th> </tr> <tr> <td>AC Charge:</td> <td>Disable</td> </tr> <tr> <td>Time Interval:</td> <td>1</td> </tr> <tr> <td>Time Active:</td> <td>Enable</td> </tr> <tr> <td>Time:</td> <td>01:00 - 05:00</td> </tr> <tr> <td>Stop Charge SOC:</td> <td>50%</td> </tr> <tr> <td>Charge Power:</td> <td>50%</td> </tr> <tr> <td colspan="2" style="text-align: center;">Setting Ok!</td> </tr> </table>	Bat First Setting		AC Charge:	Disable	Time Interval:	1	Time Active:	Enable	Time:	01:00 - 05:00	Stop Charge SOC:	50%	Charge Power:	50%	Setting Ok!	
Bat First Setting																		
AC Charge:	Disable																	
Time Interval:	1																	
Time Active:	Enable																	
Time:	01:00 - 05:00																	
Stop Charge SOC:	50%																	
Charge Power:	50%																	
Setting Ok!																		

如下是电网优先模式参数设置流程:

<table border="1"> <tr> <th colspan="2">Priority Setting</th> </tr> <tr> <td>1. Bat First Setting</td> <td style="background-color: black;"></td> </tr> <tr> <td>2. Grid First Setting</td> <td style="background-color: black;"></td> </tr> </table>	Priority Setting		1. Bat First Setting		2. Grid First Setting		<p>→</p> <p>“确认” 键</p>	<table border="1"> <tr> <th colspan="2">Grid First Setting</th> </tr> <tr> <td>Time Interval:</td> <td style="background-color: black;">1</td> </tr> <tr> <td>Time Active:</td> <td>Enable</td> </tr> <tr> <td>Time:</td> <td>01:00 - 05:00</td> </tr> <tr> <td>Stop Discharge SOC:</td> <td>50%</td> </tr> <tr> <td>Discharge Power:</td> <td>50%</td> </tr> <tr> <td colspan="2" style="text-align: center;">OK</td> </tr> </table>	Grid First Setting		Time Interval:	1	Time Active:	Enable	Time:	01:00 - 05:00	Stop Discharge SOC:	50%	Discharge Power:	50%	OK									
Priority Setting																														
1. Bat First Setting																														
2. Grid First Setting																														
Grid First Setting																														
Time Interval:	1																													
Time Active:	Enable																													
Time:	01:00 - 05:00																													
Stop Discharge SOC:	50%																													
Discharge Power:	50%																													
OK																														
<p>▼ 按“确认” 键</p>																														
<table border="1"> <tr> <th colspan="2">Grid First Setting</th> </tr> <tr> <td>Time Interval:</td> <td style="background-color: black;">1</td> </tr> <tr> <td>Time Active:</td> <td>Enable</td> </tr> <tr> <td>Time:</td> <td>01:00 - 05:00</td> </tr> <tr> <td>Stop Discharge SOC:</td> <td>50%</td> </tr> <tr> <td>Discharge Power:</td> <td>50%</td> </tr> <tr> <td colspan="2" style="text-align: center;">OK</td> </tr> </table>	Grid First Setting		Time Interval:	1	Time Active:	Enable	Time:	01:00 - 05:00	Stop Discharge SOC:	50%	Discharge Power:	50%	OK		<p>→</p> <p>按“向上” 或者 “向下” 键可选 择时间段</p>	<table border="1"> <tr> <th colspan="2">Grid First Setting</th> </tr> <tr> <td>Time Interval:</td> <td style="background-color: black;">2</td> </tr> <tr> <td>Time Active:</td> <td>Enable</td> </tr> <tr> <td>Time:</td> <td>01:00 - 05:00</td> </tr> <tr> <td>Stop Discharge SOC:</td> <td>50%</td> </tr> <tr> <td>Discharge Power:</td> <td>50%</td> </tr> <tr> <td colspan="2" style="text-align: center;">OK</td> </tr> </table>	Grid First Setting		Time Interval:	2	Time Active:	Enable	Time:	01:00 - 05:00	Stop Discharge SOC:	50%	Discharge Power:	50%	OK	
Grid First Setting																														
Time Interval:	1																													
Time Active:	Enable																													
Time:	01:00 - 05:00																													
Stop Discharge SOC:	50%																													
Discharge Power:	50%																													
OK																														
Grid First Setting																														
Time Interval:	2																													
Time Active:	Enable																													
Time:	01:00 - 05:00																													
Stop Discharge SOC:	50%																													
Discharge Power:	50%																													
OK																														
<p>▼ 按“确认” 键</p>																														
<table border="1"> <tr> <th colspan="2">Grid First Setting</th> </tr> <tr> <td>Time Interval:</td> <td>1</td> </tr> <tr> <td>Time Active:</td> <td style="background-color: black;">Enable</td> </tr> <tr> <td>Time:</td> <td>01:00 - 05:00</td> </tr> <tr> <td>Stop Discharge SOC:</td> <td>50%</td> </tr> <tr> <td>Discharge Power:</td> <td>50%</td> </tr> <tr> <td colspan="2" style="text-align: center;">OK</td> </tr> </table>	Grid First Setting		Time Interval:	1	Time Active:	Enable	Time:	01:00 - 05:00	Stop Discharge SOC:	50%	Discharge Power:	50%	OK		<p>→</p> <p>按“向上” 或者 “向下” 键可选 择使能或者禁止 时间段</p>	<table border="1"> <tr> <th colspan="2">Grid First Setting</th> </tr> <tr> <td>Time Interval:</td> <td>1</td> </tr> <tr> <td>Time Active:</td> <td style="background-color: black;">Disable</td> </tr> <tr> <td>Time:</td> <td>01:00 - 05:00</td> </tr> <tr> <td>Stop Discharge SOC:</td> <td>50%</td> </tr> <tr> <td>Discharge Power:</td> <td>50%</td> </tr> <tr> <td colspan="2" style="text-align: center;">OK</td> </tr> </table>	Grid First Setting		Time Interval:	1	Time Active:	Disable	Time:	01:00 - 05:00	Stop Discharge SOC:	50%	Discharge Power:	50%	OK	
Grid First Setting																														
Time Interval:	1																													
Time Active:	Enable																													
Time:	01:00 - 05:00																													
Stop Discharge SOC:	50%																													
Discharge Power:	50%																													
OK																														
Grid First Setting																														
Time Interval:	1																													
Time Active:	Disable																													
Time:	01:00 - 05:00																													
Stop Discharge SOC:	50%																													
Discharge Power:	50%																													
OK																														
<p>▼ 按“确认” 键</p>																														

<div style="border: 1px solid black; padding: 5px;"> <p style="text-align: center;">Grid First Setting</p> <p>Time Interval: 1</p> <p>Time Active: Disable</p> <p>Time: 01:00 - 05:00</p> <p>Stop Discharge SOC: 50%</p> <p>Discharge Power: 50%</p> <p style="text-align: center;">OK</p> </div>	 <p>按“向上”或者 “向下”键可增加或者减少时间数值</p>	<div style="border: 1px solid black; padding: 5px;"> <p style="text-align: center;">Grid First Setting</p> <p>Time Interval: 1</p> <p>Time Active: Disable</p> <p>Time: 02:00 - 05:00</p> <p>Stop Discharge SOC: 50%</p> <p>Discharge Power: 50%</p> <p style="text-align: center;">OK</p> </div>
<p>▼ 按“确认”键</p>		
<div style="border: 1px solid black; padding: 5px;"> <p style="text-align: center;">Grid First Setting</p> <p>Time Interval: 1</p> <p>Time Active: Disable</p> <p>Time: 01:00 - 05:00</p> <p>Stop Discharge SOC: 50%</p> <p>Discharge Power: 50%</p> <p style="text-align: center;">OK</p> </div>	 <p>按“向上”或者 “向下”键可增加或者减少停止放电 SOC</p>	<div style="border: 1px solid black; padding: 5px;"> <p style="text-align: center;">Grid First Setting</p> <p>Time Interval: 1</p> <p>Time Active: Disable</p> <p>Time: 01:00 - 05:00</p> <p>Stop Discharge SOC: 51%</p> <p>Discharge Power: 50%</p> <p style="text-align: center;">OK</p> </div>
<p>▼ 按“确认”键</p>		
<div style="border: 1px solid black; padding: 5px;"> <p style="text-align: center;">Grid First Setting</p> <p>Time Interval: 1</p> <p>Time Active: Disable</p> <p>Time: 01:00 - 05:00</p> <p>Stop Discharge SOC: 50%</p> <p>Discharge Power: 50%</p> <p style="text-align: center;">OK</p> </div>	 <p>按“向上”或者 “向下”键可增加或者减少放电功率百分比</p>	<div style="border: 1px solid black; padding: 5px;"> <p style="text-align: center;">Grid First Setting</p> <p>Time Interval: 1</p> <p>Time Active: Disable</p> <p>Time: 01:00 - 05:00</p> <p>Stop Discharge SOC: 50%</p> <p>Discharge Power: 51%</p> <p style="text-align: center;">OK</p> </div>
<p>▼ 按“确认”键</p>		
<div style="border: 1px solid black; padding: 5px;"> <p style="text-align: center;">Grid First Setting</p> <p>Time Interval: 1</p> <p>Time Active: Disable</p> <p>Time: 01:00 - 05:00</p> <p>Stop Discharge SOC: 50%</p> <p>Discharge Power: 50%</p> <p style="text-align: center;">OK</p> </div>	 <p>按“确认”键</p>	<div style="border: 1px solid black; padding: 5px;"> <p style="text-align: center;">Grid First Setting</p> <p>Time Interval: 1</p> <p>Time Active: Disable</p> <p>Time: 01:00 - 05:00</p> <p>Stop Discharge SOC: 50%</p> <p>Discharge Power: 50%</p> <p style="text-align: center;">Setting...</p> </div>
<p>▼ 等待 3S</p>		

		<table border="1" style="width: 100%;"> <tr> <th colspan="2" style="text-align: center;">Grid First Setting</th> </tr> <tr> <td>Time Interval:</td> <td style="text-align: right;">1</td> </tr> <tr> <td>Time Active:</td> <td style="text-align: right;">Disable</td> </tr> <tr> <td>Time:</td> <td style="text-align: right;">01:00 - 05:00</td> </tr> <tr> <td>Stop Discharge SOC:</td> <td style="text-align: right;">50%</td> </tr> <tr> <td>Discharge Power:</td> <td style="text-align: right;">50%</td> </tr> <tr> <td colspan="2" style="text-align: center;">Setting Ok!</td> </tr> </table>	Grid First Setting		Time Interval:	1	Time Active:	Disable	Time:	01:00 - 05:00	Stop Discharge SOC:	50%	Discharge Power:	50%	Setting Ok!	
Grid First Setting																
Time Interval:	1															
Time Active:	Disable															
Time:	01:00 - 05:00															
Stop Discharge SOC:	50%															
Discharge Power:	50%															
Setting Ok!																

7.2.9 自动测试设置

自动测试功能只在意大利安规下有效。其他安规，自动测试页面显示 “Not Support!”。

<table border="1" style="width: 100%;"> <tr> <th style="text-align: center;">Setting Info</th> </tr> <tr> <td> <ol style="list-style-type: none"> 1.Date & Time Setting 2.COM Address Setting 3.Language Setting 4.BAT & Meter Setting 5.Country Setting 6.Off Grid Setting 7.Priority Setting <li style="background-color: black; color: white;">8.Auto Test Setting 9.Restore Factory Setting </td> </tr> </table>	Setting Info	<ol style="list-style-type: none"> 1.Date & Time Setting 2.COM Address Setting 3.Language Setting 4.BAT & Meter Setting 5.Country Setting 6.Off Grid Setting 7.Priority Setting <li style="background-color: black; color: white;">8.Auto Test Setting 9.Restore Factory Setting 	<p>→</p> <p>按“确认”键</p>	<table border="1" style="width: 100%;"> <tr> <th style="text-align: center;">AutoTest Setting</th> </tr> <tr> <td style="text-align: center; height: 100px;">Not Support!</td> </tr> </table>	AutoTest Setting	Not Support!
Setting Info						
<ol style="list-style-type: none"> 1.Date & Time Setting 2.COM Address Setting 3.Language Setting 4.BAT & Meter Setting 5.Country Setting 6.Off Grid Setting 7.Priority Setting <li style="background-color: black; color: white;">8.Auto Test Setting 9.Restore Factory Setting 						
AutoTest Setting						
Not Support!						

意大利安规时，自动测试页面显示如下：

<table border="1" style="width: 100%;"> <tr> <th style="text-align: center;">Setting Info</th> </tr> <tr> <td> <ol style="list-style-type: none"> 1.Date & Time Setting 2.COM Address Setting 3.Language Setting 4.BAT & Meter Setting 5.Country Setting 6.Off Grid Setting 7.Priority Setting <li style="background-color: black; color: white;">8.Auto Test Setting 9.Restore Factory Setting </td> </tr> </table>	Setting Info	<ol style="list-style-type: none"> 1.Date & Time Setting 2.COM Address Setting 3.Language Setting 4.BAT & Meter Setting 5.Country Setting 6.Off Grid Setting 7.Priority Setting <li style="background-color: black; color: white;">8.Auto Test Setting 9.Restore Factory Setting 	<p>→</p> <p>按“确认”键</p>	<table border="1" style="width: 100%;"> <tr> <th style="text-align: center;">AutoTest Setting</th> </tr> <tr> <td> <table style="width: 100%;"> <tr> <td>59.S1:</td> <td style="text-align: right;">450.3V 1000ms</td> </tr> <tr> <td>27.S1:</td> <td style="text-align: right;">340.5V 1000ms</td> </tr> <tr> <td>81>.S1:</td> <td style="text-align: right;">59.15Hz 100ms</td> </tr> <tr> <td>81<.S1:</td> <td style="text-align: right;">49.80Hz 100ms</td> </tr> <tr> <td>59.S2:</td> <td style="text-align: right;">450.3V 1000ms</td> </tr> <tr> <td>27.S2:</td> <td style="text-align: right;">340.5V 1000ms</td> </tr> <tr> <td>81>.S2:</td> <td style="text-align: right;">59.15Hz 100ms</td> </tr> <tr> <td>81<.S2:</td> <td style="text-align: right;">49.80Hz 100ms</td> </tr> </table> </td> </tr> <tr> <td colspan="2" style="text-align: center;">AutoTest Start</td> </tr> </table>	AutoTest Setting	<table style="width: 100%;"> <tr> <td>59.S1:</td> <td style="text-align: right;">450.3V 1000ms</td> </tr> <tr> <td>27.S1:</td> <td style="text-align: right;">340.5V 1000ms</td> </tr> <tr> <td>81>.S1:</td> <td style="text-align: right;">59.15Hz 100ms</td> </tr> <tr> <td>81<.S1:</td> <td style="text-align: right;">49.80Hz 100ms</td> </tr> <tr> <td>59.S2:</td> <td style="text-align: right;">450.3V 1000ms</td> </tr> <tr> <td>27.S2:</td> <td style="text-align: right;">340.5V 1000ms</td> </tr> <tr> <td>81>.S2:</td> <td style="text-align: right;">59.15Hz 100ms</td> </tr> <tr> <td>81<.S2:</td> <td style="text-align: right;">49.80Hz 100ms</td> </tr> </table>	59.S1:	450.3V 1000ms	27.S1:	340.5V 1000ms	81>.S1:	59.15Hz 100ms	81<.S1:	49.80Hz 100ms	59.S2:	450.3V 1000ms	27.S2:	340.5V 1000ms	81>.S2:	59.15Hz 100ms	81<.S2:	49.80Hz 100ms	AutoTest Start	
Setting Info																								
<ol style="list-style-type: none"> 1.Date & Time Setting 2.COM Address Setting 3.Language Setting 4.BAT & Meter Setting 5.Country Setting 6.Off Grid Setting 7.Priority Setting <li style="background-color: black; color: white;">8.Auto Test Setting 9.Restore Factory Setting 																								
AutoTest Setting																								
<table style="width: 100%;"> <tr> <td>59.S1:</td> <td style="text-align: right;">450.3V 1000ms</td> </tr> <tr> <td>27.S1:</td> <td style="text-align: right;">340.5V 1000ms</td> </tr> <tr> <td>81>.S1:</td> <td style="text-align: right;">59.15Hz 100ms</td> </tr> <tr> <td>81<.S1:</td> <td style="text-align: right;">49.80Hz 100ms</td> </tr> <tr> <td>59.S2:</td> <td style="text-align: right;">450.3V 1000ms</td> </tr> <tr> <td>27.S2:</td> <td style="text-align: right;">340.5V 1000ms</td> </tr> <tr> <td>81>.S2:</td> <td style="text-align: right;">59.15Hz 100ms</td> </tr> <tr> <td>81<.S2:</td> <td style="text-align: right;">49.80Hz 100ms</td> </tr> </table>	59.S1:	450.3V 1000ms	27.S1:	340.5V 1000ms	81>.S1:	59.15Hz 100ms	81<.S1:	49.80Hz 100ms	59.S2:	450.3V 1000ms	27.S2:	340.5V 1000ms	81>.S2:	59.15Hz 100ms	81<.S2:	49.80Hz 100ms								
59.S1:	450.3V 1000ms																							
27.S1:	340.5V 1000ms																							
81>.S1:	59.15Hz 100ms																							
81<.S1:	49.80Hz 100ms																							
59.S2:	450.3V 1000ms																							
27.S2:	340.5V 1000ms																							
81>.S2:	59.15Hz 100ms																							
81<.S2:	49.80Hz 100ms																							
AutoTest Start																								

启动测试后，Real 值随时间变化。

<table border="1" style="width: 100%;"> <tr> <th style="text-align: center;">AutoTest Setting</th> </tr> <tr> <td> <table style="width: 100%;"> <tr> <td>59.S1:</td> <td style="text-align: right;">450.3V 1000ms</td> </tr> <tr> <td>27.S1:</td> <td style="text-align: right;">340.5V 1000ms</td> </tr> <tr> <td>81>.S1:</td> <td style="text-align: right;">59.15Hz 100ms</td> </tr> <tr> <td>81<.S1:</td> <td style="text-align: right;">49.80Hz 100ms</td> </tr> <tr> <td>59.S2:</td> <td style="text-align: right;">450.3V 1000ms</td> </tr> <tr> <td>27.S2:</td> <td style="text-align: right;">340.5V 1000ms</td> </tr> <tr> <td>81>.S2:</td> <td style="text-align: right;">59.15Hz 100ms</td> </tr> <tr> <td>81<.S2:</td> <td style="text-align: right;">49.80Hz 100ms</td> </tr> </table> </td> </tr> <tr> <td colspan="2" style="text-align: center;">AutoTest Start</td> </tr> </table>	AutoTest Setting	<table style="width: 100%;"> <tr> <td>59.S1:</td> <td style="text-align: right;">450.3V 1000ms</td> </tr> <tr> <td>27.S1:</td> <td style="text-align: right;">340.5V 1000ms</td> </tr> <tr> <td>81>.S1:</td> <td style="text-align: right;">59.15Hz 100ms</td> </tr> <tr> <td>81<.S1:</td> <td style="text-align: right;">49.80Hz 100ms</td> </tr> <tr> <td>59.S2:</td> <td style="text-align: right;">450.3V 1000ms</td> </tr> <tr> <td>27.S2:</td> <td style="text-align: right;">340.5V 1000ms</td> </tr> <tr> <td>81>.S2:</td> <td style="text-align: right;">59.15Hz 100ms</td> </tr> <tr> <td>81<.S2:</td> <td style="text-align: right;">49.80Hz 100ms</td> </tr> </table>	59.S1:	450.3V 1000ms	27.S1:	340.5V 1000ms	81>.S1:	59.15Hz 100ms	81<.S1:	49.80Hz 100ms	59.S2:	450.3V 1000ms	27.S2:	340.5V 1000ms	81>.S2:	59.15Hz 100ms	81<.S2:	49.80Hz 100ms	AutoTest Start		<p>→</p> <p>按“确认”键</p>	<table border="1" style="width: 100%;"> <tr> <th style="text-align: center;">AutoTest Setting</th> </tr> <tr> <td>Auto Testing ...</td> </tr> <tr> <td>Step:</td> <td style="text-align: right;">59.S1</td> </tr> <tr> <td>Limit:</td> <td style="text-align: right;">450.3V 1000ms</td> </tr> <tr> <td>Real:</td> <td style="text-align: right;">400.5V</td> </tr> </table>	AutoTest Setting	Auto Testing ...	Step:	59.S1	Limit:	450.3V 1000ms	Real:	400.5V
AutoTest Setting																														
<table style="width: 100%;"> <tr> <td>59.S1:</td> <td style="text-align: right;">450.3V 1000ms</td> </tr> <tr> <td>27.S1:</td> <td style="text-align: right;">340.5V 1000ms</td> </tr> <tr> <td>81>.S1:</td> <td style="text-align: right;">59.15Hz 100ms</td> </tr> <tr> <td>81<.S1:</td> <td style="text-align: right;">49.80Hz 100ms</td> </tr> <tr> <td>59.S2:</td> <td style="text-align: right;">450.3V 1000ms</td> </tr> <tr> <td>27.S2:</td> <td style="text-align: right;">340.5V 1000ms</td> </tr> <tr> <td>81>.S2:</td> <td style="text-align: right;">59.15Hz 100ms</td> </tr> <tr> <td>81<.S2:</td> <td style="text-align: right;">49.80Hz 100ms</td> </tr> </table>	59.S1:	450.3V 1000ms	27.S1:	340.5V 1000ms	81>.S1:	59.15Hz 100ms	81<.S1:	49.80Hz 100ms	59.S2:	450.3V 1000ms	27.S2:	340.5V 1000ms	81>.S2:	59.15Hz 100ms	81<.S2:	49.80Hz 100ms														
59.S1:	450.3V 1000ms																													
27.S1:	340.5V 1000ms																													
81>.S1:	59.15Hz 100ms																													
81<.S1:	49.80Hz 100ms																													
59.S2:	450.3V 1000ms																													
27.S2:	340.5V 1000ms																													
81>.S2:	59.15Hz 100ms																													
81<.S2:	49.80Hz 100ms																													
AutoTest Start																														
AutoTest Setting																														
Auto Testing ...																														
Step:	59.S1																													
Limit:	450.3V 1000ms																													
Real:	400.5V																													

单项测试完成后，显示单项触发阈值和单项测试结果。

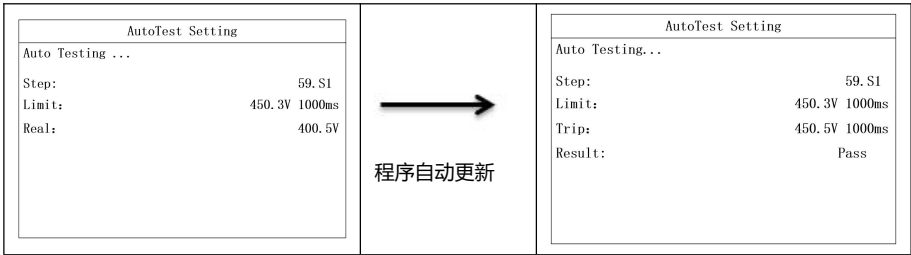

所有测试项结束后，显示自动测试结果和所有测试项的触发阈值。

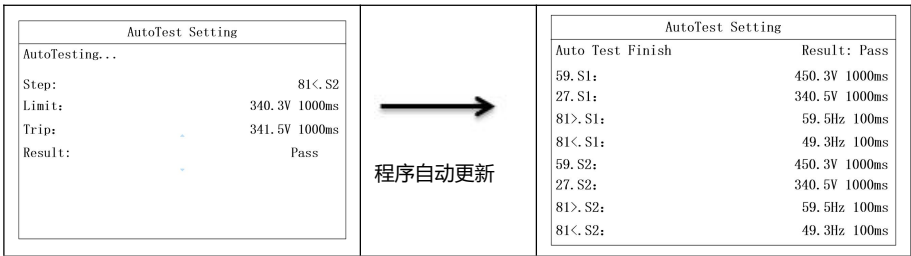

7.2.10 恢复出厂设置

恢复出厂设置功能可以把校准数据和配置参数恢复为默认参数，也可以清除电能数据和历史故障数据。

恢复出厂设置流程如下：

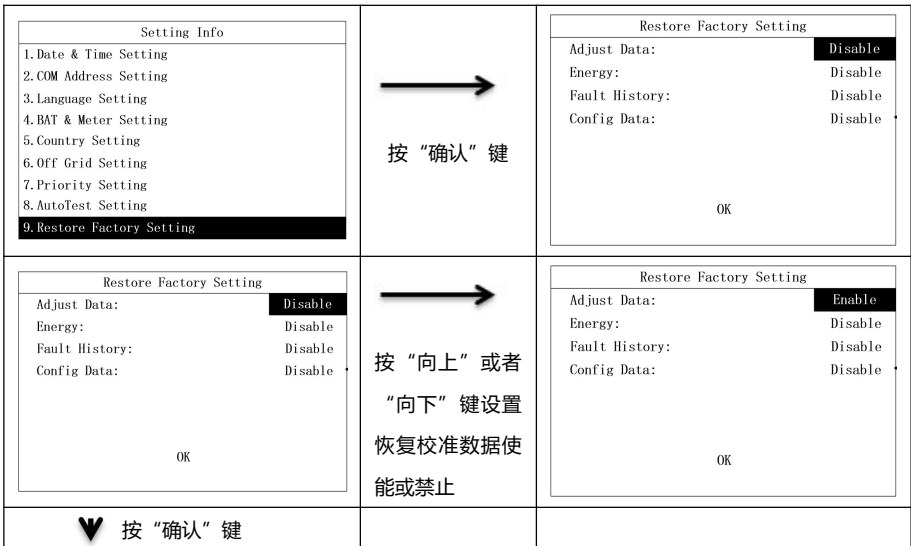





<table border="1"> <thead> <tr> <th colspan="2">Restore Factory Setting</th> </tr> </thead> <tbody> <tr> <td>Adjust Data:</td> <td>Disable</td> </tr> <tr> <td>Energy:</td> <td>Disable</td> </tr> <tr> <td>Fault History:</td> <td>Disable</td> </tr> <tr> <td>Config Data:</td> <td>Disable</td> </tr> <tr> <td colspan="2" style="text-align: center;">OK</td> </tr> </tbody> </table>	Restore Factory Setting		Adjust Data:	Disable	Energy:	Disable	Fault History:	Disable	Config Data:	Disable	OK		<p style="text-align: center;">→</p> <p>按“向上”或者“向下”键设置清除电能数据使能或禁止</p>	<table border="1"> <thead> <tr> <th colspan="2">Restore Factory Setting</th> </tr> </thead> <tbody> <tr> <td>Adjust Data:</td> <td>Disable</td> </tr> <tr> <td>Energy:</td> <td>Enable</td> </tr> <tr> <td>Fault History:</td> <td>Disable</td> </tr> <tr> <td>Config Data:</td> <td>Disable</td> </tr> <tr> <td colspan="2" style="text-align: center;">OK</td> </tr> </tbody> </table>	Restore Factory Setting		Adjust Data:	Disable	Energy:	Enable	Fault History:	Disable	Config Data:	Disable	OK	
Restore Factory Setting																										
Adjust Data:	Disable																									
Energy:	Disable																									
Fault History:	Disable																									
Config Data:	Disable																									
OK																										
Restore Factory Setting																										
Adjust Data:	Disable																									
Energy:	Enable																									
Fault History:	Disable																									
Config Data:	Disable																									
OK																										
<p>▼ 按“确认”键</p>																										
<table border="1"> <thead> <tr> <th colspan="2">Restore Factory Setting</th> </tr> </thead> <tbody> <tr> <td>Adjust Data:</td> <td>Disable</td> </tr> <tr> <td>Energy:</td> <td>Disable</td> </tr> <tr> <td>Fault History:</td> <td>Disable</td> </tr> <tr> <td>Config Data:</td> <td>Disable</td> </tr> <tr> <td colspan="2" style="text-align: center;">OK</td> </tr> </tbody> </table>	Restore Factory Setting		Adjust Data:	Disable	Energy:	Disable	Fault History:	Disable	Config Data:	Disable	OK		<p style="text-align: center;">→</p> <p>按“向上”或者“向下”键设置清除历史故障信息使能或禁止</p>	<table border="1"> <thead> <tr> <th colspan="2">Restore Factory Setting</th> </tr> </thead> <tbody> <tr> <td>Adjust Data:</td> <td>Disable</td> </tr> <tr> <td>Energy:</td> <td>Disable</td> </tr> <tr> <td>Fault History:</td> <td>Enable</td> </tr> <tr> <td>Config Data:</td> <td>Disable</td> </tr> <tr> <td colspan="2" style="text-align: center;">OK</td> </tr> </tbody> </table>	Restore Factory Setting		Adjust Data:	Disable	Energy:	Disable	Fault History:	Enable	Config Data:	Disable	OK	
Restore Factory Setting																										
Adjust Data:	Disable																									
Energy:	Disable																									
Fault History:	Disable																									
Config Data:	Disable																									
OK																										
Restore Factory Setting																										
Adjust Data:	Disable																									
Energy:	Disable																									
Fault History:	Enable																									
Config Data:	Disable																									
OK																										
<p>▼ 按“确认”键</p>																										
<table border="1"> <thead> <tr> <th colspan="2">Restore Factory Setting</th> </tr> </thead> <tbody> <tr> <td>Adjust Data:</td> <td>Disable</td> </tr> <tr> <td>Energy:</td> <td>Disable</td> </tr> <tr> <td>Fault History:</td> <td>Disable</td> </tr> <tr> <td>Config Data:</td> <td>Disable</td> </tr> <tr> <td colspan="2" style="text-align: center;">OK</td> </tr> </tbody> </table>	Restore Factory Setting		Adjust Data:	Disable	Energy:	Disable	Fault History:	Disable	Config Data:	Disable	OK		<p style="text-align: center;">→</p> <p>按“向上”或者“向下”键设置恢复配置数据使能或禁止</p>	<table border="1"> <thead> <tr> <th colspan="2">Restore Factory Setting</th> </tr> </thead> <tbody> <tr> <td>Adjust Data:</td> <td>Disable</td> </tr> <tr> <td>Energy:</td> <td>Disable</td> </tr> <tr> <td>Fault History:</td> <td>Disable</td> </tr> <tr> <td>Config Data:</td> <td>Enable</td> </tr> <tr> <td colspan="2" style="text-align: center;">OK</td> </tr> </tbody> </table>	Restore Factory Setting		Adjust Data:	Disable	Energy:	Disable	Fault History:	Disable	Config Data:	Enable	OK	
Restore Factory Setting																										
Adjust Data:	Disable																									
Energy:	Disable																									
Fault History:	Disable																									
Config Data:	Disable																									
OK																										
Restore Factory Setting																										
Adjust Data:	Disable																									
Energy:	Disable																									
Fault History:	Disable																									
Config Data:	Enable																									
OK																										
<table border="1"> <thead> <tr> <th colspan="2">Restore Factory Setting</th> </tr> </thead> <tbody> <tr> <td>Adjust Data:</td> <td>Disable</td> </tr> <tr> <td>Energy Data:</td> <td>Disable</td> </tr> <tr> <td>Fault History:</td> <td>Disable</td> </tr> <tr> <td>Config Data:</td> <td>Disable</td> </tr> <tr> <td colspan="2" style="text-align: center;">OK</td> </tr> </tbody> </table>	Restore Factory Setting		Adjust Data:	Disable	Energy Data:	Disable	Fault History:	Disable	Config Data:	Disable	OK		<p style="text-align: center;">→</p> <p>按“确认”键</p>	<table border="1"> <thead> <tr> <th colspan="2">Restore Factory Setting</th> </tr> </thead> <tbody> <tr> <td>Adjust Data:</td> <td>Disable</td> </tr> <tr> <td>Energy Data:</td> <td>Disable</td> </tr> <tr> <td>Fault History:</td> <td>Disable</td> </tr> <tr> <td>Config Data:</td> <td>Disable</td> </tr> <tr> <td colspan="2" style="text-align: center;">Setting...</td> </tr> </tbody> </table>	Restore Factory Setting		Adjust Data:	Disable	Energy Data:	Disable	Fault History:	Disable	Config Data:	Disable	Setting...	
Restore Factory Setting																										
Adjust Data:	Disable																									
Energy Data:	Disable																									
Fault History:	Disable																									
Config Data:	Disable																									
OK																										
Restore Factory Setting																										
Adjust Data:	Disable																									
Energy Data:	Disable																									
Fault History:	Disable																									
Config Data:	Disable																									
Setting...																										
<p>▼ 等待 10s</p>																										

		<table border="1"> <tr> <th colspan="2">Restore Factory Setting</th> </tr> <tr> <td>Adjust Data:</td> <td>Disable</td> </tr> <tr> <td>Energy Data:</td> <td>Disable</td> </tr> <tr> <td>Fault History:</td> <td>Disable</td> </tr> <tr> <td>Config Data:</td> <td>Disable</td> </tr> <tr> <td colspan="2" style="text-align: center;">Setting Ok!</td> </tr> </table>	Restore Factory Setting		Adjust Data:	Disable	Energy Data:	Disable	Fault History:	Disable	Config Data:	Disable	Setting Ok!	
Restore Factory Setting														
Adjust Data:	Disable													
Energy Data:	Disable													
Fault History:	Disable													
Config Data:	Disable													
Setting Ok!														

7.2.11 防逆流电表设置

防逆流电表设置可以设置是否使能防逆流电表，选择电表的类型，限制电网功率。

<table border="1"> <tr> <th colspan="2">Setting Info</th> </tr> <tr> <td>10. Anti-Reflex Setting</td> <td></td> </tr> <tr> <td>11. Set Parallel Role</td> <td></td> </tr> </table>	Setting Info		10. Anti-Reflex Setting		11. Set Parallel Role			<table border="1"> <tr> <th colspan="2">Meter Setting</th> </tr> <tr> <td>Anti-Reflex:</td> <td>Disable</td> </tr> <tr> <td>Sensor:</td> <td>CT</td> </tr> <tr> <td>Power Limit</td> <td>000kw</td> </tr> <tr> <td colspan="2" style="text-align: center;">OK</td> </tr> </table>	Meter Setting		Anti-Reflex:	Disable	Sensor:	CT	Power Limit	000kw	OK					
Setting Info																						
10. Anti-Reflex Setting																						
11. Set Parallel Role																						
Meter Setting																						
Anti-Reflex:	Disable																					
Sensor:	CT																					
Power Limit	000kw																					
OK																						
<p>▼ 按“确认”键</p>																						
<table border="1"> <tr> <th colspan="2">Meter Setting</th> </tr> <tr> <td>Anti-Reflex:</td> <td>Disable</td> </tr> <tr> <td>Sensor:</td> <td>CT</td> </tr> <tr> <td>Power Limit</td> <td>000kw</td> </tr> <tr> <td colspan="2" style="text-align: center;">OK</td> </tr> </table>	Meter Setting		Anti-Reflex:	Disable	Sensor:	CT	Power Limit	000kw	OK			<table border="1"> <tr> <th colspan="2">Meter Setting</th> </tr> <tr> <td>Anti-Reflex:</td> <td>Disable</td> </tr> <tr> <td>Sensor:</td> <td>CHINTT Meter</td> </tr> <tr> <td>Power Limit</td> <td>000kw</td> </tr> <tr> <td colspan="2" style="text-align: center;">OK</td> </tr> </table>	Meter Setting		Anti-Reflex:	Disable	Sensor:	CHINTT Meter	Power Limit	000kw	OK	
Meter Setting																						
Anti-Reflex:	Disable																					
Sensor:	CT																					
Power Limit	000kw																					
OK																						
Meter Setting																						
Anti-Reflex:	Disable																					
Sensor:	CHINTT Meter																					
Power Limit	000kw																					
OK																						
<p>▼ 按“确认”键</p>																						
<table border="1"> <tr> <th colspan="2">Meter Setting</th> </tr> <tr> <td>Anti-Reflex:</td> <td>Disable</td> </tr> <tr> <td>Sensor:</td> <td>CT</td> </tr> <tr> <td>Power Limit</td> <td>000kw</td> </tr> <tr> <td colspan="2" style="text-align: center;">OK</td> </tr> </table>	Meter Setting		Anti-Reflex:	Disable	Sensor:	CT	Power Limit	000kw	OK			<table border="1"> <tr> <th colspan="2">Meter Setting</th> </tr> <tr> <td>Anti-Reflex:</td> <td>Disable</td> </tr> <tr> <td>Sensor:</td> <td>CT</td> </tr> <tr> <td>Power Limit</td> <td>100kw</td> </tr> <tr> <td colspan="2" style="text-align: center;">OK</td> </tr> </table>	Meter Setting		Anti-Reflex:	Disable	Sensor:	CT	Power Limit	100kw	OK	
Meter Setting																						
Anti-Reflex:	Disable																					
Sensor:	CT																					
Power Limit	000kw																					
OK																						
Meter Setting																						
Anti-Reflex:	Disable																					
Sensor:	CT																					
Power Limit	100kw																					
OK																						
<p>▼ 按“确认”键</p>																						
																						
	<p>按 UP 和 Down 限制买/卖电功率。</p>																					

<p>▼ 按“确认”键</p>														
<div style="border: 1px solid black; padding: 5px;"> <p style="text-align: center;">Meter Setting</p> <table style="width: 100%; border-collapse: collapse;"> <tr> <td style="width: 50%;">Anti-Reflex:</td> <td style="width: 50%;">Disable</td> </tr> <tr> <td>Sensor:</td> <td>CT</td> </tr> <tr> <td>Power Limit</td> <td>100Kw</td> </tr> </table> <p style="text-align: center; margin-top: 10px;">OK</p> </div>	Anti-Reflex:	Disable	Sensor:	CT	Power Limit	100Kw	<p>→</p> <p>Enter 录入设置信息</p>	<div style="border: 1px solid black; padding: 5px;"> <p style="text-align: center;">Meter Setting</p> <table style="width: 100%; border-collapse: collapse;"> <tr> <td style="width: 50%;">Anti-Reflex:</td> <td style="width: 50%;">Disable</td> </tr> <tr> <td>Sensor:</td> <td>CT</td> </tr> <tr> <td>Power Limit</td> <td>100Kw</td> </tr> </table> <p style="text-align: center; margin-top: 10px;">Setting OK!</p> </div>	Anti-Reflex:	Disable	Sensor:	CT	Power Limit	100Kw
Anti-Reflex:	Disable													
Sensor:	CT													
Power Limit	100Kw													
Anti-Reflex:	Disable													
Sensor:	CT													
Power Limit	100Kw													

7.2.12 并网角色设置

<div style="border: 1px solid black; padding: 5px;"> <p style="text-align: center;">Setting Info</p> <p>10. Anti-Reflex Setting</p> <p style="background-color: black; color: white; padding: 2px;">11. Set Parallel Role</p> </div>	<p>→</p> <p>按 Enter 进入界面。 按 Up 或 Down 将该设备设置为主机或者从机。</p>	<div style="border: 1px solid black; padding: 5px;"> <p style="text-align: center;">Set Parallel Role</p> <p style="background-color: black; color: white; padding: 2px;">Role: 1 Phase Master</p> <p style="text-align: center; margin-top: 20px;">OK</p> </div>
<p>▼ 按“确认”键</p>		
<div style="border: 1px solid black; padding: 5px;"> <p style="text-align: center;">Set Parallel Role</p> <p>Role: 2 Slave</p> <p style="text-align: center; margin-top: 10px;">OK</p> </div>	<p>→</p> <p>按 Enter 设置参数, 完成自动跳转。</p>	<div style="border: 1px solid black; padding: 5px;"> <p style="text-align: center;">Set Parallel Role</p> <p>Role: 2 Slave</p> <p style="text-align: center; margin-top: 10px;">Setting Ok!/Fail!</p> </div>

第 8 章 系统调试

8.1 显示屏和按键

8.1.1 LCD 显示屏



图 8-1

位置	描述
A	状态
B	故障告警码
C	485 通讯
D	CAN 通讯
E	USB
F	电表
G	故障告警
H	日期
I	时间
J	PV 输入
K	PV 功率
L	储能逆变器

M	蓄电池（共分 5 格，每格表示 20%）
N	电池功率
O	电网
P	电网功率
Q	关键负载
R	负载功率
S	能量流动指示箭头

8.1.2 LED 灯和屏幕按键说明

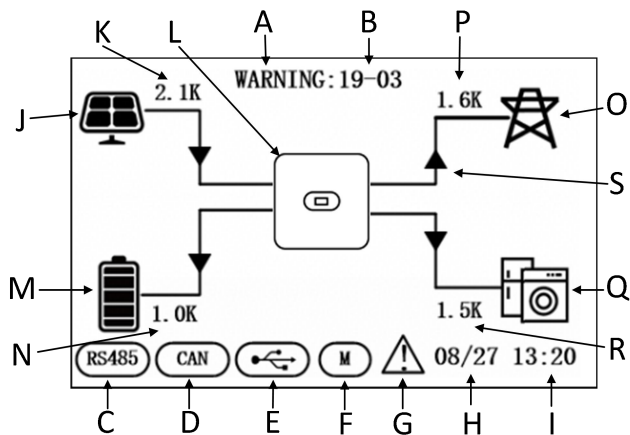

图 8-2

位置	释义
1	绿灯，绿灯常亮代表储能逆变器处于并网状态
	绿灯闪烁代表代表储能逆变器处于自检状态
	绿灯和黄灯闪烁代表储能逆变器处于代码烧录状态，
2	黄灯，黄灯常亮代表储能逆变器处于离网状态
3	红灯，红灯常亮代表储能逆变器处于故障状态
4	LCD 屏
5	返回键
6	确认键
7	向上键
8	向下键

8.2 工作模式

8.2.1 正常模式

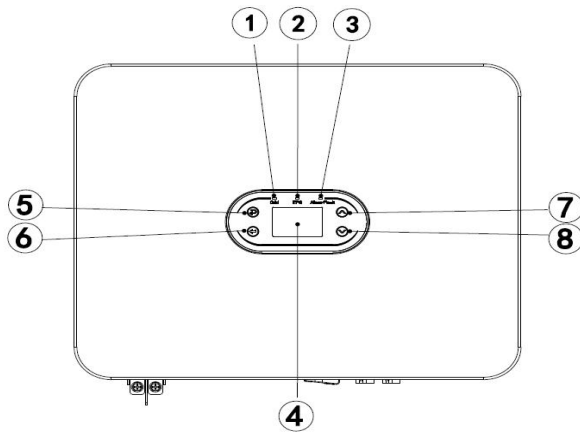
正常模式包含并网模式和离网模式两种工作状态。

并网模式

当储能逆变器工作在并网模式下时，您可以根据您的需求设置一种优先模式。如果用户通过 LCD 设置，每种优先模式只能设置一个时间段；如果通过网页设置，每种优先模式最高可以设置三个时间段。

1. 负载优先：默认模式为负载优先。当系统工作在此模式下时，光伏能量将优先提供给负载。当光伏不能满足负载需求时，电池开始放电。当光伏完全满足负载需求时，多余的电量将被存储到电池中。如果没有电池或电池已经充满的情况下，多余电量将并入电网（无防逆流情况下）。

2. 电池优先：当系统工作在此模式下时，将优先给电池充电。当需要启动市电给电池充电的时候，用户需要使能 AC 充电（市电充电）功能，同时需要设置启动和结束充电时间以及电池 SOC 点，如果没有使能 AC 充电（市电充电）功能，储能逆变器将只能通过光伏给电池充电。另外，客户也可以设定功率百分比，功率百分比设定为电池工作的最大功率，在电池优先模式下，电池放电不能超过此限定功率值。

3. 电网优先：当系统工作在此模式下时，光伏所产生的电能将优先并网。用户可以在高峰期将电量送到电网，在此模式下，用户可以设置启动和结束充电时间以及电池 SOC 点，另外，客户也可以设定功率百分比，功率百分比设定为电池工作的最大功率，在电网优先模式下，电池放电不能超过此限定功率值。

离网模式

当电网断电的情况下，系统将自动转为离网模式（用户可以关闭这一功能，具体参见 9.1），

此时 EPS 输出端口将会输出电压，系统通过电池和太阳能给负载供电，需要注意的是，在此模式下，储能逆变器最大输出功率为 6000W，所以 EPS 端口负载功率不应超过 6000W。

注意：

1. 在电网优先和电池优先模式下，通过 LCD 只能设置一个充放电的时间段，而如果需要设置更多的时间段，请通过 Solarman 进行设置。

2. 如果您希望通过电网给电池充电，您需要在输入登录密码并设置 AC 充电使能。

8.2.2 故障状态

英威腾储能逆变器拥有智能控制系统，可以持续监测和调节系统状态。当出现系统故障或设备故障时，在 LCD 屏上将会显示故障信息，在故障模式下，LED 灯也将点亮。

注意：

A) 详细的故障信息请参见 10.1 节。

B) 部分故障信息是用于提醒用户储能机内部可能出现故障。

8.2.3 固件升级

储能逆变器正在固件升级时，请勿断电；当升级完成后机器将会自动跳转至正常工作模式。

8.2.4 自检状态

在进入正常工作模式以前，储能逆变器会先进入自检状态。如果一切正常，系统将进入正常工作模式；否则将进入故障状态。

8.2.5 待机状态

当系统并未出现故障但某种运行条件尚未满足时，储能逆变器将会进入待机状态。

8.2.6 关机状态

如果您希望储能逆变器停止工作，您必须断开所有的能量来源，然后储能逆变器会自动进入关机模式。

具体步骤如下：

1. 断开 PV 侧；
2. 关闭电池开关；
3. 断开电网。此时 LED 灯及 LCD 屏均熄灭。

注意：当以上操作均完成后，您仍然需要至少等待 5 分钟后进行其他操作。

注意

当以上操作均完成后，您仍然需要至少等待5分钟后进行其他操作。

8.3 通过 Solarman App 设置储能逆变器参数

注意：为确保逆变器正常工作，请先使用 Solarman App 完成储能逆变器参数设置。

注意

为确保逆变器正常工作，请先使用Solarman App完成储能逆变器参数设置。

Solarman App 是一款可通过 WiFi 模块或 GPRS 模块与储能逆变器进行通讯的手机应用软件。以下为常用功能：

1. 查看储能逆变器的运行数据、软件版本、告警信息等。
2. 设置储能逆变器的电网参数、通讯参数等。
3. 维护设备。
4. 升级设备软件版本。

详情请参见《Solarman APP 用户手册》，用户手册可从官网 <https://www.invt.com/>获取。

第 9 章 系统维护

英威腾产品出厂前会进行一系列严格测试，为确保和延长逆变器的使用寿命，除严格按照本说明书规定的内容使用逆变器外，还需要对逆变器进行必要的日常维护与检修。

确保逆变器已断电。

操作逆变器时，请佩戴个人防护用品。

9.1 逆变器定期维护

检查内容	检查方法	维护周期
保存逆变器运行数据	采用监控软件实时读取逆变器的数据，并定期备份监控软件记录的数据。保存监控软件中所记录的逆变器的运行数据、参数以及日志到文件中。检查监控软件和通过手持键盘查看逆变器各项参数设置。	每季度 1 次
逆变器运行状况	观察逆变器安装是否牢固，是否有损坏或变形。听逆变器运行是否有异常声音。在系统并网运行时，检查各项变量。检查逆变器外壳发热是否正常，使用热成像仪等监测系统发热情况。	每半年 1 次
逆变器清洁	检查逆变器周围环境的湿度与灰尘，如影响到机器散热，请停机断电，待机器冷却后使用软刷或干布进行清理。	每半年 1 次
直流开关	将直流开关连接打开、关闭 10 次，确保直流开关功能正常	每年 1 次
电气连接	检查系统电缆连接是否松动，逆变器接线端子是否松动。检查电缆有无损伤，尤其是与金属表面接触的表皮是否有割伤的痕迹。	每半年 1 次
密封性	检查设备进线孔密封性是否满足要求，如果出现缝隙太大或未封堵，需重新封堵	每年一次
安全功能	检查逆变器 LCD 以及系统的停机功能。模拟停机，并检查停机信号通讯。检查警告标签，如果有必要及时更换。	每年 1 次

9.2 逆变器下电

危险

• 逆变器进行操作维护时，请将逆变器下电处理，带电操作设备可能导致逆变器损坏或发生电击危险。

• 逆变器断电后，内部元器件放电需要一定时间，请根据需标签时间要求等待至设备完全放电。

步骤 1：断开逆变器 ON-GRID 交流断路器。

步骤 2：断开逆变器 BACK-UP 交流断路器。

步骤 3: 断开逆变器与电池之间的储能断路器。

9.3 拆除逆变器

步骤 1: 断开逆变器所有的电气连接,包括: 直流线、交流线、通信线、通信模块、保护地线。

步骤 2: 将逆变器从背挂板上取下。

步骤 3: 拆除背挂板。

步骤 4: 妥善保存逆变器, 如果后续逆变器还需投入使用, 确存储条件满足要求。

9.4 报废逆变器

逆变器无法继续使用, 需要报废时, 请根据逆变器所在国家/地区法规的电气垃圾处理要求进行处置逆变器, 不能将逆变器当生活垃圾处理。

第 10 章 故障检修

故障代码与故障处理



警告

非专业人员请联系供应商处理，检查前请做好防护措施，严禁带电操作！

本章内容介绍故障告警及代码，用于快速查找逆变器故障。

请根据以下方法进行故障排查，如果排查方法无法帮助您，请联系售后服务中心，

联系售后服务中心时，请收集以下信息，便于快速解决问题。

- 逆变器型号：_____；
 - 逆变器序列号：_____；
 - 逆变器系统版本号——版本 1：_____；
——版本 2：_____；
——MCU 软件版本：_____；
 - 故障代码：_____；
 - 设备安装环境：_____；
- 故障现象简单描述：_____。

表 10-1 逆变器故障代码

序号	故障类型	故障代码	故障信息	解决措施
1	PV 电压故障	01-01	PV 电压低	请检查光伏面板连接是否正常，面板是否存在损坏或表面积灰、有遮挡物的情况。
		01-02	PV 电压高	请检查光伏面板是否连接正常，面板电压规格是否高于逆变器工作电压范围。
		01-03	PV 面板短路	请检查光伏面板是否存在短路情况。
2	BUS 电压错误	03-01	BUS 电压低	多出现在清晨，请检查光伏面板表面清洁程度。
		03-02	BUS 电压高	请检查光伏面板是否连接正常，面板电压规格是否高于逆变器工作电压范围。
		03-04	硬件 bus 过压	请重启逆变器，若故障未能消除，请联系经销商。
3	过流故障	05-01	逆变硬件过流	请重启逆变器，若故障未能消除，请联系经销商。
		05-02	逆变软件过流	
		05-03	BOOST 硬件过流	
		05-04	BOOST 软件过流	
		05-05	辅源硬件 TZ 故障	
		05-06	Bus 硬件 TZ 过压	
		05-07	LLC 侧硬件 TZ 故障	
		05-08	Buck-Boost 软件过流	
4	温度异常故障	06-01	逆变温度异常	请检查逆变器温度，若温度过高，请冷却后使用。
		06-02	BOOST 异常	
		06-03	散热器异常	
		06-04	环境异常	
		06-05	Buck-Boost 温度异常	
		06-06	NTC 开路	
5	绝缘检测故障	07-01	绝缘检测故障	请确认逆变器及光伏面板是否可靠接地，请断电 5 分钟后再重新上电，若故障未能清除，请联系经销商。
6	驱动故障	08-01	驱动故障	请重启逆变器，若故障未能消除，请联系经销商。
7	通信故障	09-01	主 DSP 接收 ARM	请重启逆变器，若故障未能消除，请联系经销商。

序号	故障类型	故障代码	故障信息	解决措施
			通讯故障	经销商
		09-02	ARM 接收主 DSP 通讯故障	
		09-03	副 DSP 接收 ARM 通讯故障	
		09-04	ARM 接收副 DSP 通讯故障	
		09-05	主从芯片通讯故障-主芯片故障	请重启逆变器, 若故障未能消除, 请联系经销商。
		09-06	主从芯片通讯故障-从芯片故障	请重启逆变器, 若故障未能消除, 请联系经销商。
		09-07	DSP 与 AFCI 通信故障	请重启逆变器, 若故障未能消除, 请联系经销商。
8	漏电流故障	10-01	静态漏电流高	1.如果偶然出现, 可能是外部线路偶然异常导致, 重启逆变器后会恢复正常工作。 2.如果频繁出现或长时间无法恢复, 请检查光伏组串接地是否可靠。
		10-02	30mA 突变故障	
		10-03	60mA 突变故障	
		10-04	150mA 突变故障	
9	继电器故障	11-01	继电器开路	请重启逆变器, 若故障未能消除, 请联系经销商。
		11-02	继电器短路	
10	内部风扇故障	12-01	内部风扇故障	请重启逆变器, 若故障未能消除, 请联系经销商。
11	DCI 故障	14-01	R 相 DCI 故障	请确认逆变器及光伏面板是否可靠接地, 请断电 5 分钟后再重新上电, 若故障未能清除, 请联系经销商。
12	一致性故障	19-01	AC 电压检测不一致	请重启逆变器, 若故障未能消除, 请联系经销商。
		19-02	BUS 电压检测不一致	
		19-03	ISO 电压检测不一致	
		19-04	PV 电压检测不一致	
		19-05	GFCI 不一致	
		19-06	Bus 电压采样异常	
		19-07	PV 电流采样异常	

序号	故障类型	故障代码	故障信息	解决措施
13	市电电压故障	31-01	市电欠压 1 阶	1.如偶然出现, 为电网瞬时出现异常, 电网恢复正常后逆变器会恢复正常工作; 2.如频繁报此故障, 请检查电网是否异常。
		31-02	市电过压 1 阶	
		31-03	无市电电压	请检查市电是否正常。
		31-04	市电欠压 2 阶	1.如偶然出现, 为电网瞬时出现异常, 电网恢复正常后逆变器会恢复正常工作; 2.如频繁报此故障, 请检查电网是否异常。
		31-05	市电过压 2 阶	
		31-06	市电启动欠压	
		31-07	市电启动过压	
		31-08	中断瞬时过压	
		31-09	孤岛过压	
		31-10	电网电压震荡	
14	市电频率故障	33-01	市电欠频 1 阶	1.如偶然出现, 为电网瞬时出现异常, 电网恢复正常后逆变器会恢复正常工作; 2.如频繁报此故障, 请检查电网是否异常。
		33-02	市电过频 1 阶	
		33-03	市电欠频 2 阶	
		33-04	市电过频 2 阶	
		33-05	市电启动欠频	
		33-06	市电启动过频	
15	远程关机	37-01	远程关机指令	请检查是否人为对逆变器设置了关机。
16	AFCI 故障	38-01	组串 1 故障	请将逆变器关机并断开输入输出开关, 5 分钟后重启逆变器, 若故障未能清除, 请联系经销商。
		38-02	组串 2 故障	
17	AFCI 自检故障	39-01	组串 1 自检故障	请将逆变器关机并断开输入输出开关, 5 分钟后重启逆变器, 若故障未能清除, 请联系经销商。
		39-02	组串 2 自检故障	
18	AutoTest 故障	41-01	自动测试失败故障	请将逆变器关机并断开输入输出开关, 5 分钟后重启逆变器, 若故障未能清除, 请联系经销商。
19	N-PE 故障	42-01	N-PE 电压异常故障	请检查逆变器 AC 侧接线是否正确且牢固。
20	漏电流自检故障	43-01	漏电流传感器故障	请将逆变器关机并断开输入输出开关, 5 分钟后重启逆变器, 若故障未能清除, 请联系经销商。
21	组串检测故障	44-01	组串故障	请将逆变器关机并断开输入输出开关, 5 分钟后重启逆变器, 若故障未能清除, 请联系

序号	故障类型	故障代码	故障信息	解决措施
				经销商。
22	辅助电源故障	45-01	辅助电源掉电	请将逆变器关机并断开输入输出开关，5分钟后重启逆变器，若故障未能清除，请联系经销商。
23	EPS 短路故障	46-01	EPS 短路故障	请检查 EPS 端口输出接线是否正确。
24	并机故障	40-1	多主机故障	请检查主从机设置
		40-2	并机 CAN 通讯故障	请检查并机 CAN 接线
		40-3	主机丢失故障	1.请检查并机 CAN 接线 2.请检查主从机设置
		40-4	同步过零故障	1.请检查并机 CAN 接线 2.请检查主从机设置

表 10-2 逆变器告警代码

序号	故障类型	故障代码	故障信息	显示信息
1	风扇转速低	01-07	内部风扇 1	请将逆变器关机并断开输入输出开关，5 分钟后重启逆变器，若故障未能清除，请联系经销商。
2	防逆流电表通讯	04-01	电表异常警告	请检查电表接线是否异常，供电是否正常。
		04-08	电表通讯异常警告	请检查电表接线是否异常，供电是否正常。
		04-16	CT 接线异常警告	请检查 CT 接线是否正常。
3	电网超范围告警	05-00	电压超范围告警	1.如偶然出现，为电网瞬时出现异常，电网恢复正常后逆变器会恢复正常工作； 2.如频繁报此故障，请检查电网是否异常。
4	PV 短路告警	06-01	PV1 短路告警	请检查光伏输入是否异常，线路是否出现短路。
		06-02	PV2 短路告警	
5	过载告警	07-01	EPS 过载告警	请减少 EPS 端负载功率。
6	电池充满	46-01	电池充满	电池已经充满。
7	电池亏电	47-01	电池需要充电	请为电池充电。
		47-02	电池只能充电	请检查模式设置，请为电池充电。
8	EPS 过载告警	07-01	EPS 功率超 1.5 倍	请减少 EPS 端负载功率。
		07-02	EPS 功率超 1.2 倍	
		07-03	EPS 功率超 1.1 倍	
		07-04	EPS 电流超 1.5 倍	
		07-05	EPS 电流超 1.2 倍	
		07-06	EPS 电流超 1.1 倍	

第 11 章 规格参数

	XD3KTL	XD3K6TL	XD4KTL	XD4K6TL	XD5KTL	XD6KTL
电池参数						
电池类型	锂电池, 铅酸电池					
电池电压范围 (V)	40-60					
最大充放电电流 (A)	100					
通讯方式	CAN					
输入 (直流)						
最大输入功率 (W)	4500	5400	6000	6900	7500	9000
最大输入电压 (V)	600					
启动电压 (V)	100					
额定电压 (V)	240	240	270	300	330	360
MPPT 电压范围	100-550					
MPPT 数量	2					
最大输入电流 (A)	16					
最大输入短路电流 (A)	20					
输出 (交流)						
额定输出功率 (VA)	3000	3680	4000	4600	5000	6000
最大输出功率 (VA)	3300	3680	4400	4600	5500	6600
最大输出电流 (A)	15	16	20	20.9	22.7	30
额定电压 (V)	230					
额定频率 (Hz)	50					
电流总谐波失真 (@ 额定功率)	< 3%					
功率因素	0.8 超前~0.8 滞后					
离网输出						
最大输出功率 (VA)	3000	3680	4000	4600	5000	6000
最大输出电流 (A)	15	16	20	20.9	22.7	30

峰值输出功率, 时间 (KW,s)	4.5,10	5.4,10	6,10	6.9,10	7.5,10	9,10
额定输出电压, 频率 (V, Hz)	230, 50					
THDv(@额定功率)	< 3%					
切换时间 (ms)	< 10					
效率						
最大效率	> 97.5%					
欧洲效率	> 97.2%					
充放电效率	> 95%					
保护						
防反/绝缘阻抗/接地保护	具备					
过流/过压保护	具备					
电池软启动保护	具备					
AFCI 防护	选配					
防雷保护	二级					
常规参数						
环境温度范围	-30°C ~ +60°C					
待机损耗 (W)	< 10					
拓扑	高频隔离 (对电池)					
防护等级	IP66					
相对湿度	0~100%					
通讯	RS485&CAN&WiFi&4G&LAN&蓝牙					
最大工作海拔 (m)	4000					
噪音	≤25dB					
冷却方式	自然冷却					
显示	LCD					
尺寸	490*395*200					
重量	21.35Kg					



服务热线: +86 400 700 9997 邮箱: solar-service@invt.com.cn 网址: www.invt-solar.com

深圳市英威腾光伏科技有限公司

深圳市光明区马田街道松白路英威腾光明科技大厦 B 座 2 楼

产品在改进的同时, 资料可能有所改动, 恕不另行通知。版权所有, 仿冒必究。

202310 (V1.0)